

Identification of the Wreck of the U.S.C.S.S. *Robert J. Walker* off Atlantic City, New Jersey



Prepared by

James P. Delgado, Ph.D.
Director of Maritime Heritage

**With contributions from Capt. Albert Theberge, Vitad Pradith, Ole Varmer,
Lydia Barbash-Riley, Joyce Steinmetz, Dawn Forsythe, Matthew Lawrence,
Russell Green, and Tane Casserley**

July 2013

**NOAA's Office of National Marine Sanctuaries
Silver Spring, Maryland**



Abstract

From June 21 to 24, 2013, a NOAA team from the Office of Coast Survey and the Office of National Marine Sanctuaries conducted a joint mission to characterize a shipwreck off the coast of New Jersey near Absecon Inlet and Atlantic City. While known to and regularly visited by recreational SCUBA divers, the shipwreck was brought to NOAA's attention by archaeologist Joyce Steinmetz, who hypothesized that it was the remains of the U. S. Coast Survey Steamer *Robert J. Walker*. However, the shipwreck had not undergone any archaeological assessment to provide evidence to either affirm or refute this identification. During the June 2013 fieldwork, hydrographers on the NOAA Ship *Thomas Jefferson* surveyed the site and its surroundings with high-resolution multibeam and side-scan sonar. This work was followed by a close order side scan sonar survey and archaeological SCUBA dives conducted from the NOAA R/V *SRVx* that acoustically and visually characterized the shipwreck and its debris field. The data gathered by the project confirmed that the shipwreck was U.S.C.S.S. *Robert J. Walker*, lost off Absecon Inlet on June 21, 1860.

Previous Site Investigations

The wreck site recently identified as the U.S.C.S. *Robert J. Walker* has been “known” since the Second World War as an obstruction, as a targeted “poss. WWI freighter” (AWOIS 2480), and finally as a fisherman's hang-up that was known and transmitted to local wreck divers in the early 1970s – when it became known as the “\$25 wreck” – and diving on the site commenced. NOAA's Office of Coast Survey surveyed the shipwreck with multibeam sonar in 2004 and obtained information about the wreck's basic characteristics and orientation during an overall charting of the area. This survey determined that the wreck was approximately 40 meters or 134 feet in length. The data suggested that the vessel's hull was articulated with material projecting into the water column at its ends and in a central mass suggestive of engine(s) and boiler(s). Coast Survey designated the wreck as an obstruction and updated navigation charts to reflect this hazard. The identity of the wreck was not suspected by NOAA officials at that time.

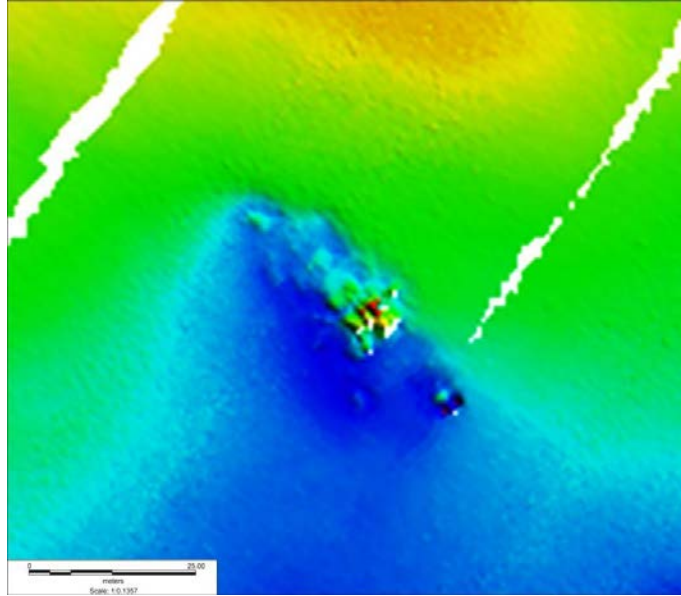

The wreck site in 2004 (NOAA/OCS)

Whereas NOAA officials knew little of the shipwreck's particulars, local divers had been attempting to identify the shipwreck for some time. According to interviews with local divers conducted by Steinmetz (Steinmetz 2010, 2013), divers made the following observations over the last four decades:

- The wreck lies 85' deep, in a mud/silt hole offshore of a 60' shoal.
- The wreck was characterized by metal frames and an iron plated hull.
- It has or had side-mounted paddlewheels.
- There is a large "toppled" engine, "lying on its side."
- The bow is "separated" from wreck by 100 feet. As for the wreck, it "feels like it is not all there."
- Divers had recovered "Mason's" ironstone china and a single cannonball. Patented in Great Britain in 1813 by Charles James Mason, ironstone was a popular style quickly introduced to the United States as a trade item. Mason sold his patent in 1851 to Francis Morley, who replaced Mason's name on the patented ironstone thence manufactured (Blacker 1911:193).
- Among the artifacts recovered were rectangular bronze or brass portholes.



One of the portholes recovered from the wreck site (Joyce Steinmetz)

The rectangular portholes were of particular note; several have been recovered, and they are unusual as most portholes and their deadlights are circular.

New Jersey has an active corps of wreck divers, many of whom invest considerable personal sums to outfit dive expeditions to locate and identify the many wrecks off the shore. Some collect artifacts, others do not. A number of these divers have donated their finds to the New Jersey Maritime Museum, a non-profit educational institution located in Beach Haven, New Jersey. Others retain their finds in personal collections. Without the attention paid to this wreck by New Jersey wreck divers, its presence and ultimate identification as *Robert J. Walker* would not have occurred.

The website <http://www.njwreckdivers.com/p/shipwreck-info.html> notes:

In the early seventies the wreck was discovered by a local fisherman and the Loran co-ordinate was sold for \$25 dollars to a local party boat. Hence its original name, the \$25 Dollar Wreck. Captain Ed Boyle of the original Atlantic City dive boat Gypsy began taking charters to the wreck, discovering barrels, square portholes, a large toppled engine with an upright bow and two paddlewheels in the debris. The starboard paddle was standing vertical and the port lays on its side in the sand. Visibility was often limited at that time, because a sewage outfall pipe north of the wreck was still in operation, and the wreck remained infrequently visited. The untreated outfall was capped in the mid-eighties and soon visibility greatly improved. On a dive in the late eighties Atlantic Divers discovered a barrel of white china with the markings labeled Mason on the bottom. Because of the previous names

bad reputation, Atlantic Divers rechristen [sic] the wreck Mason's paddle Wheeler to stimulate more exploration of the site. Soon it became a popular dive and much discovery continued. Dave Keller recovered a large brass steam vent with a thermometer enclosed. Several bottles, and more pieces of china have been uncovered since that time and numerous copper pipe lay ambiguously in the debris. Today the water is clear over the wreck with a healthy abundance of marine life. More needs to be uncovered to verify its identity (njwreckdivers 2013).

Another diver, Kim Dixon, discussed the wreck in her dive blog for July 30, 2011:

The \$25 wreck is an unknown wreck from the 1800's. It basically consists of the engine block and wooden side paddle wheels. My hubby, Bill, got a nice glass inkwell off of this wreck many years ago and I know there are plenty more artifacts to be found on this wreck. It was not too long and we were anchored up on the wreck... I splashed to unlimited visibility and also a pretty stiff current... About 70' the visibility dissipated and the water column became filled with salps and lots of particulate matter... I'd say the visibility on the bottom was only about 10"... I tied off near the anchor and headed in an unknown direction that lead me to the engine and one of the side paddle wheels... I found the other side paddle wheel and you could see all the spokes on it and also the giant anchor.... I had a nice 30 minute dive and decided to head up to the surface. The current was ripping during the hang
(http://www.kimdixondiving.blogspot.com/2011_07_01_archive.html).

East Coast Diving describes the wreck on their website:

This wreck... are the remains of a side paddle wheel steamship lying in 90' of water 11 miles off the coast of Ocean City, N.J. The wreck is low and scattered and consists of the engine and paddlewheel shafts, some scattered hull sections and the remains of the bow 50" forward of the engine. Probably sunk in the late 1800s, this interesting wreck has produced portholes and is a good spot for lobster
(<http://eastcoastdiving.com/index.php/local-dives>).

The New Jersey wreck divers website currently suggests that the wreck is the paddle steamer *Florida*, lost in 1892. *Florida*, research indicates, wrecked closer to shore and on the beach.

Historical Background

Robert J. Walker was built in the first half of the nineteenth century, when the United States Government was expanding its role in surveying, marking, and control of coastal waters. It was also a time, with the Industrial Revolution, when steam technology as well as iron hulls were being adopted in the maritime and naval communities. Britain's Royal Navy adopted steam as a means of propulsion in the early 19th century, although interest in the technology dated to the end of the last century. American interest paralleled Britain's, with the first steam paddle warship in America, Robert Fulton's *Demologos*, a single, central paddle-propelled craft, being briefly tested and abandoned in 1815. These early steamers were wooden-hulled; it would not be until 1820 when the first all-iron hull, the British steamer *Aaron Manby*, would be built.

Commercial vessels, not naval, became the primary means by which steam technology advanced, but official (and naval) interest continued to monitor developments and, in 1821, Britain launched its first paddle vessel for the navy, the steam tug *Comet* (Brown 1993:11). This was followed by a spate of smaller paddle steamers, twenty in number, through the 1830s. In 1831, the Royal Navy had fourteen steamships, eight of them in commission (Brown 1993:16). Small, and fitted with oscillating or side-lever steam engines ranging from 80, 100, 136, 140, and 200 nominal horsepower, these vessels were ultimately armed and many served through the 1860s (Brown 1933:13-16). The 1830s and 1840s were a period of continued adoption of steam, and experiments in design of the hulls, machinery and propulsion. Brown (1993) called it "a time of change" as Britain ordered its first iron-hulled steamer in January 1843. Launched by Ditchburn & Mare in 1846, the 850-ton, 180-foot long, 31-foot, 6-inch beam steamer *Trident* was classified as third-class sloop fitted with a Boulton & Watt oscillating engine rated at 350 nominal horsepower and armed with two 10-inch guns on pivot mounts and two 32-pdr. carronades (Brown 1993:42). During the same period, the United States Navy continued to experiment with steam vessels and by the mid-1840s had launched twenty steam vessels including frigates, sloops, and gunboats into service (<http://shipbuildinghistory.com/history/navalships/unsteam.htm>).

Within two years of *Trident's* completion, Britain laid down its last paddlewheel-driven warship, *Barracouta*, in 1848 (Brown 1993:42). Iron hulls did not weigh as much as a comparable wooden hull (about 20 percent less) and had smaller frames and bulkheads possessing about 20 percent more internal space. As a rigid structure, iron hulls were "better able to resist vibration" from steam machinery than wood. While not always favored because of the brittle nature of wrought iron, improvements in metal technology and steam machinery in the 1850s and 1860s, and the battle success of ironclads in the Civil War, ultimately led to the abandonment of wooden-hulled warships as well as merchant steamers.

Built for the United States Revenue Marine Service for the enforcement of customs, *Walker* was one of eight transitional iron-hulled steamers constructed in the 1840s by the United States Government to “naval designs.” The government was also testing, through practical application, various theories of construction and propulsion – in the latter, different types of paddlewheels as well as propellers. There was enthusiasm in the ranks of the Revenue Marine for iron hulls. Captain William A. Howard wrote that not only would iron-hulled steamers be stronger than wood, but they would also not rot, be damaged by marine borers, and would cost 50 percent less to repair over a 20-year time period than a comparable wooden ship (Browning 1992:26).

The Commandant of the Revenue Marine, Captain Alexander V. Fraser, wrote in the 1843 annual report of the USRM:

The principle advantages arising from the use of iron are; economy in the original construction; durability, lightness of material, and consequently, increased buoyancy; increased strength, particularly in the ability to withstand shocks sustained by taking the ground when passing shoal water bars; and the value when worn out, of the old materials (Fraser 1843 as cited in Smith 1989:59).

At the same time, the U.S. Navy was also building iron steamers. One, the gunboat USS *Michigan*, was built expressly for service on the Great Lakes (Rodgers 1996). While this was a period of steady adoption of iron in shipbuilding, it remained highly individualistic as various yards and builders experimented. A few decades into the process, the major marine insurance company in the world, Lloyds of London, had not adopted standards for iron ships as the technology was “still in its infancy” without any “well-understood general rules” (Lloyds 1884:77).

The Revenue Marine proceeded with an initial request for bids to construct six iron steamers in April 1843, and soon had contracts in place to build the steamers *Spencer*, *Bibb*, *Dallas*, and *McLane*, with an experimental paddlewheel invented by naval officer William W. Hunter, and two steamers, *Legare* and *Jefferson*, with helicoidal propellers designed by inventor John Ericsson (Browning 1992:27). The contracts for the six steamers were followed by contracts for two sidewheel steamships, *Polk* and *Walker*, in December 1844 and January 1845. While work on the last two steamers progressed – slowly – the Hunter wheel-propelled vessels proved to be failures. They were leaky, slow and inefficient in their consumption of coal and in excessive wear and tear on their machinery, which necessitated expensive repairs and cost overruns. Ultimately, some of the vessels were refitted with new propulsion systems and were ultimately transferred out of the Revenue Marine.

Polk was completed at Richmond, Virginia, in March 1847. Meanwhile, work on the last of the iron steamers, *Robert J. Walker*, slowly progressed. Named for United States Senator Robert John Walker of Mississippi (1801-1869), who served as Secretary of the Treasury in the cabinet of President James K. Polk from 1845 to 1849, *Walker* was built at the Pittsburgh, Pennsylvania, shipyard of Joseph Tomlinson in 1847 (Department of the Treasury 1847:68) at a cost of \$104,825.53.

Tomlinson and his business partner Samuel Stackhouse were ship and engine-builders of considerable reputation. Tomlinson, a Philadelphia native, had come to Pittsburgh in 1816 with his parents. He went on to establish an iron foundry and machine shop. During the War of 1812, the foundry he purchased had provided Oliver Hazard Perry's ships with anchors. Under Tomlinson, it was said, the foundry built more "boats" than any other shipbuilder in the old Northwest territory of the United States, west of Pennsylvania and northwest of the Ohio River (Rodgers 1996:11). In addition to ships and engines, Tomlinson later built rail cars; he also constructed two ironclad river monitors for the U.S. Navy at the end of the Civil War.

In September 1844, the Philadelphia *North American* reported that the government was contracting to build iron steamships in Pittsburgh, and noted the recent launch of the iron steamer USS *Michigan*:

One of the steamers built here, is now ploughing the waters of Lake Erie; and her performances are spoken of as incomparable. Her sheet iron planks, ribs, engines, boilers &c. in fact all and every part of her iron works were manufactured and prepared at Pittsburgh, and taken to Erie and put together. The contractors were Tomlinson & Co. (Philadelphia *North American*, September 18, 1844)

The revenue steamers were to serve in key coastal ports. *Walker* was destined for Mobile Bay. "The models are furnished by the Navy Department, and side wheels have been ordered, as being best tested and least liable to failure" (Columbus *Ohio Statesman*, March 14, 1845).

The contract to build *Walker* was issued in 1846, but work did not commence until March 1847. Delays in obtaining the iron from the mill and bad weather delayed the start of work. Disputes between the Revenue Marine and Tomlinson, and poor quality construction drawings, led to an order to defer the launch of the steamer for a few months (Browning 1992:34). Tomlinson finally launched the 358-ton *Robert J. Walker* on November 27, 1847. Richard Evans, the Commandant of the Revenue Marine and also serving as *Walker's* master, called the steamer "the finest iron vessel ever built in this country" (Browning 1992:34).

After being rigged (*Walker* carried two masts with a brigantine rig) and being fitted with its 32-pdr. guns and ammunition, the steamer left Pittsburgh on December 14

for New Orleans and thence to its home port of Mobile on December 14, 1847 (Pittsburgh *Daily Gazette*, May 4, November 29, December 15, 1847). On that date, the *Semi-Weekly Natchez Courier* noted that the “new iron steamer ‘Robert J. Walker’, lately built at Pittsburgh, has been launched, and may soon be expected down the Mississippi River, on her way to the Gulf of Mexico” (Natchez, Mississippi *Semi-Weekly Natchez Courier*, December 14, 1847).

Soon after arrival, instead of heading to Mobile, *Walker* was transferred by the Revenue Marine to the United States Coast Survey at New Orleans on February 11, 1848. The reason for the quick transfer was explained in 1852 by Benjamin Isherwood, Chief Engineer of the United States Navy:

The experiment tried by the Treasury, of substituting steam for sailing cutters, having signally failed from the too large size of the steamers, the expense of maintaining them, and the abortive character of their machinery and propelling instruments, they were either turned over to the Coast Survey, or otherwise disposed of. Of the eight, only three now remain in the Government service, viz: the *Legarè*, the *Bibb*, and the *Walker*, and they are employed as Surveying Steamers (Isherwood 1852:49-50).

The United States Coast Survey, established in 1807, was expanding its coastal surveys under an energetic new Superintendent, Alexander Dallas Bache. Bache was appointed in 1843 to succeed the first Superintendent Ferdinand Hassler, who had initially led the Survey from 1816-1818, and then resumed his post when the Survey was reauthorized and commenced duties again in 1832. Robert J. Walker, incidentally, was a brother-in-law of Alexander Dallas Bache, who now had a vessel in his fleet named for a family member.¹

The U.S. Coast Survey’s officers had watched the arrival of steam with considerable interest, and advocated the use of steamers in survey because of the “independence of steam against wind and tide”:

Having the means of going in any direction, the surveyor is able to make a comprehensive and careful project of his work, and to carry it out with certainty; while, with sails only, he is obliged to accommodate his traverse to the direction of the wind and the course of the tide, and generally much time is lost in retracing his steps to windward to

¹ The Coast Survey Schooner *Sophia* (1855-1861) was named for Alexander Dallas Bache’s mother. Reports mention *Sophia* as a tender in the Florida Keys in 1861. Sophia Dallas Bache (1789-1860), was daughter of sixth Secretary of the Treasury Alexander J. Dallas and sister of Vice President George M. Dallas who served under President Polk.

obtain a suitable position... the most favorable days for sounding are those on which the sea is calm, and then the steamer will accomplish the best work, both in amount and quality; but the sailing vessel lies idle for want of motive power. When sounding in deep water, it is often necessary to lessen the speed in order to get the depth accurately, and to ascertain the character of the bottom. The steam vessel does this easily, without diverging from her track; the sail vessel must change her course and lie to. By this, time is lost, labor is increased, and the continuity of the lines is broken (Coast Survey 1847:85).

Therefore, while the Revenue Marine was less than happy with their new steamers' failure as armed vessels patrolling and requiring fast response time, this was not a requirement for a survey steamship. The United States Coast Survey was also a sister agency of the Revenue Marine Service (also known as the Revenue Cutter Service), and both operated under the auspices of the United States Treasury Department. The Revenue Marine temporarily reverted to sailing vessels while the Coast Survey embraced steam technology, particularly for offshore operations. The first of these vessels was *Bibb*, followed by *Walker*, *Legare*, and *Jefferson*. An additional steam vessel, *Hetzel*, was transferred from the Army quartermaster department while a small steamer, *Active*, was procured on the Pacific coast, following the loss of *Jefferson* on the coast of Patagonia while in transit to San Francisco.

As NOAA historian Albert Theberge notes, *Walker* joined the Coast Survey at a pivotal time in its history.

Coast Survey experienced a remarkable expansion in its operations and responsibilities. Geographically, the coasts of Texas, Washington, Oregon, and California were added to the United States. New projects were begun and old functions expanded. The coastal triangulation network was continued north into Maine and south to Cape Hatteras, while beginnings of survey work were made in South Carolina, Georgia, Florida, Alabama, Mississippi, Louisiana, and Texas. Survey crews were sent to the western coast, although work did not begin there in earnest until 1850. The Coast Survey, in a project that heralded the beginnings of modern oceanography, commenced studies of the Gulf Stream in 1845. Many improvements were introduced in instrumentation and methodology that greatly improved the efficiency and accuracy of the work. The project to determine the differences of longitude between prominent points on the eastern seaboard of the United States and European observatories continued. The major hydrographic accomplishment of this half decade was the survey of Nantucket Shoals. These few years marked the period when Bache placed his indelible stamp upon the Coast Survey and were halcyon

days with discoveries, inventions, and increased responsibilities coming one after the other (Theberge 1998:144).

In a mutually beneficial arrangement, naval officers were assigned to the Coast Survey. This afforded early command opportunities for these officers as well as training them in aspects of navigation, charting, inshore piloting, and other naval skills. With the addition of steam vessels, the Coast Survey became even more desirable as a training ground. For many naval officers attached to the Survey at this time, this was their first experience with steam vessels, preparing them for the upcoming conflict. The commanding officers of these vessels read like a “Who’s Who” of Civil War fame as David Dixon Porter, John Rodgers, Samuel Philips Lee, C.R.P. Rodgers, Thornton Jenkins, Daniel Ammen, C. H. McBlair and engineer Alban Stimers, among others, all served with the Coast Survey’s steamships. These ships became an intrinsic part of great national endeavors driven by remarkable changes in transportation technology, new insights in science, and the unprecedented expansion of United States coastline in the first half of the 19th century.

Lieutenant (Commanding) Carlile P. Patterson (1816-1881) was the *Walker’s* first Coast Survey commanding officer, assuming his post in Mobile from Capt. Evans of the Revenue Marine. Patterson served with the Coast Survey with distinction as a naval officer on detached service, and commanded the Survey’s first vessel in the Gulf of Mexico, the schooner *Phoenix*, in 1845. After commanding *Walker*, Patterson resigned and headed into merchant service with the Pacific Mail Steamship Company, commanding the steamers *Oregon* and *Golden Gate* on their regular voyages from Panama to San Francisco from 1849 to 1853. Patterson was in command when PMSSC *Oregon* brought the news to San Francisco that California had been granted U.S. statehood. He remained in the west until 1861 with his family. Returning east with the Civil War, Patterson rejoined the Coast Survey and in 1874 became Superintendent, a post he held until his death.

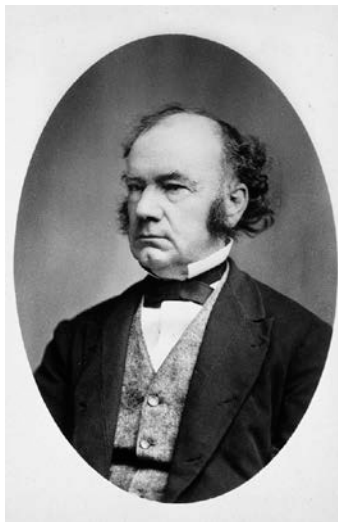

Carlile Patterson (NOAA Central Library)

Patterson was followed as captain of *Walker* in quick progression by Lieutenant James Alden (1810-1877), a promising naval officer who had served in the Wilkes Expedition, on board USS *Constitution* on a global cruise, and in the Mexico War, where he served with the Home Squadron off Mexico. Detached for Coast Survey duty, from the summer of 1849 through the late winter of 1851, Alden commanded the steamer *John Y. Mason* and then *Walker*. From *Walker* he went west to command the Pacific Coast-based steamer *Active* until 1860. A distinguished Civil War career saw Alden promoted to Captain and then Commodore, and postwar he served as a Rear Admiral commanding the European Fleet of the U.S. Navy.



James Alden (National Archives)

Walker's next commander was Samuel Phillips Lee (1812-1897), who would also rise to positions of prominence in naval rank as a Civil War Rear Admiral and commander of the North Atlantic Blockading Squadron, the Mississippi Squadron, and the postwar North Atlantic Squadron of the U.S. Navy.

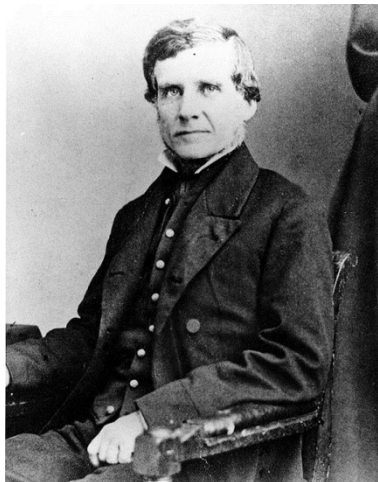

Samuel Phillips Lee (Naval History and Heritage Command H48279)

The next commanding officer of *Walker* after Samuel P. Lee, and the longest serving master of the steamer, was Benjamin Franklin Sands (1811-1883). Sands' autobiography notes that he took command in March 1851 in Mobile, and commenced surveys from Pensacola to the mouth of the Mississippi before taking *Walker* out of the Gulf to Hampton Roads, and thence to Baltimore, where he laid up the steamer. He and the crew continued working local waters in two smaller coastal schooners (Sands 1899:213). Reactivating *Walker* in December 1852, Sands took the steamer back into the Gulf, where he commanded it through 1857. Of that time on board, he wrote:

I was engaged upon this interesting hydrographic work in the Gulf of Mexico, the fields of my especial surveys being the Florida Keys and the west coast of that state, including Cedar Keys, Tampa Bay and Pensacola Harbor, thence west, taking in the Bay of Biloxi, Chaudelaur Sound, the Deltas of the Mississippi, and the westward thereof, including Atchafalaya Bay and Sabine Pass on the Texas Coast (Sands 1899:213).

Sands and his crew aboard *Walker* also charted portions of the Gulf Stream from Florida to Cape Hatteras in 1855, which was a key interest of Superintendent Bache (Sands 1899:214).

Benjamin Sands, like his predecessors, enjoyed a prominent career that included early Coast Survey duty in the 1830s and early 1840s, and service in the Gulf during the Mexican War. He served with distinction on post-Mexican War Coast Survey duty, including his time on *Walker*. Sands' Civil War service was as a captain in blockading squadrons on the Atlantic and in the Gulf, and a post-Civil War career as Superintendent of the U.S. Naval Observatory. In 1871, Commodore Sands was promoted to Rear Admiral.

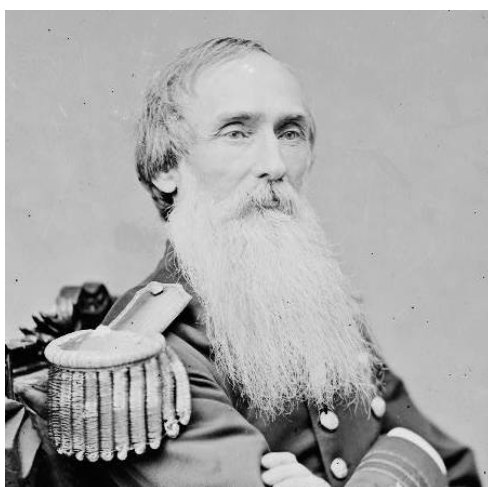

Benjamin Franklin Sands (National Archives)

As the list of commanders shows, *Walker* served as a training platform for a number of officers eager to learn the operation of steamships at a time when there were not enough of the vessels to provide an opportunity for all who had the interest or desire to learn. Among those assigned to *Walker* from the U.S. Navy was Alban C. Stimers, a 25-year old second engineer attached to the ship on November 18, 1852. Stimers rose rapidly in naval ranks and during the Civil War served as a Chief Engineer in the United States Navy. He played a major role in working with John Ericsson on the construction of USS *Monitor*, and sailed with the ironclad, although not a member of the crew, on its famous voyage south in 1862; he was onboard during the resulting battle with CSS *Virginia*, the former USS *Merrimac*.



Alban C. Stimers (Naval History and Heritage Command H44389)

Walker's executive officer in 1855, William Gamble, went on to command the ironclad USS *Osage* in 1865 and retired as a commander. Another noted *Walker* crew member was a young officer, Joseph Fry, who served aboard in 1850-1851. Fry left the Navy with the advent of the Civil War and was a blockade runner for the Confederacy. "On the beach" after the war, Fry accepted the position of master of the commercial steamer *Virginus*, chartered by Cuban nationalists to run guns into Cuba to support an uprising against the island's Spanish rulers. *Virginus* was captured off Cuba by a Spanish warship on October 30, 1874. The "*Virginus* Affair" was one of the more prominent diplomatic crises faced by the United States in the late 19th century. Fry and his crew were imprisoned, tried as pirates, and most were executed within days despite diplomatic protests in the notorious case that inflamed passions on both sides of the Atlantic and nearly brought Spain and the United States to war.

Walker's crews were diverse and included naval and merchant marine veterans, immigrants, foreign nationals, and a racially diverse crew which often included African-Americans. *Walker* figured in an incident involving one of its black sailors

while in Charleston in what seems to have been late 1858. The sailor, G.E. Stevens, explained in a letter to J.C. White from Pensacola on early January 8, 1859:

My duty on board this ship required that I should go ashore. The laws of South Carolina forbade my doing so. The day after I arrived I was ordered ashore and obeyed. When walking up King Street I was seized and arraigned before the Mayor. Fortunately for me, a young gentleman, a friend of Captain Huger (the Capt. of the *Walker*) saw the arrest and informed him immediately. The Captain rendered securities and I was released. (As quoted in Sterling 1973:219.)

Thomas Bee Huger (1820-1862), *Walker's* commanding officer at the time of Stevens' arrest, joined the U.S. Navy as a midshipman in 1835, served in the Mediterranean and Home Squadrons, and was promoted to lieutenant in 1848. Assigned to the Coast Survey, Huger was the lieutenant (commanding) of *Walker* in 1859, replacing B.F. Sands, and remained in command until early 1860; although when the steamer was lost, he was no longer in command. Huger resigned from the Coast Survey and the Navy in 1861 and joined the Confederacy. As commander of the gunboat *McRae*, he was mortally wounded during the Union assault at the mouth of the Mississippi on April 24, 1862, and died of his wounds the following day.



Thomas Bee Huger (Naval History and Heritage Command H66631)

Walker's Coast Survey Career

(with contributions from Albert Theberge)

The Coast Survey Steamer *Robert J. Walker* was a small ship that accomplished a large job. Over the course of its career, its crew acquired over 900,000 hand lead-line soundings, charted the Gulf Coast from Mobile Bay to the Mississippi Passes, and made a substantial contribution to opening up many of the Gulf ports to

increased commerce. In addition, its work served to help prepare the Union Navy for planning actions on the Gulf Coast including the attack on New Orleans, the blockade of a number of ports, the establishment of Ship Island as a major base of operations, and the Battle of Mobile Bay. It also made contributions to the science of the Gulf of Mexico region by helping: 1) detail changes in bottom configuration of various areas with the passage of storms; 2) document the changing nature of the marshes of the Mississippi Delta region; 3) understand the tides of the Gulf of Mexico; and 4) understand the bottom configuration of the deep Gulf of Mexico by obtaining some of the first deep sea soundings in the Gulf. It made contributions far out of proportion to its physical stature as a small steamer with relatively small crews to the commercial, military, and scientific history of the Gulf Coast region. After transfer from the Revenue Service, *Walker* was assigned to the portion of the United States coastline designated Section VIII by the Coast Survey. This section extended from Dauphin Island to Vermillion Bay including the coasts of Alabama, Mississippi, and Louisiana. The primary working area of *Walker* remained Section VIII for the next eleven years.

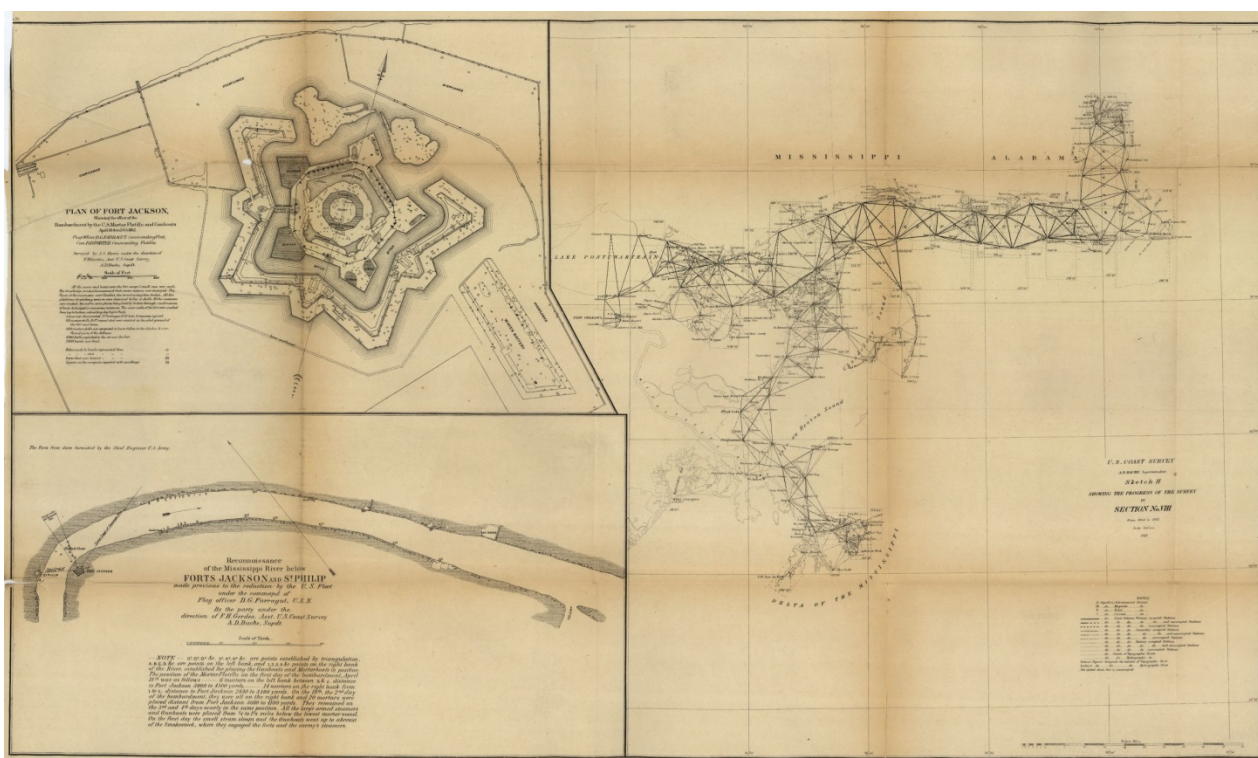

1862 chart delineating *Walker's* area of work, but also most of the work completed by the crew of the steamer during its Coast Survey career. Interestingly, this particular graphic includes insets of the mortar boat attacks on Forts Jackson and St. Philip – attacks made possible by the geodetic work of the Coast Survey and the innovative naval mind of David Dixon Porter, commandant of the mortar boat fleet here. “Sketch H. showing the progress of the survey in section no. VIII, from 1846 to 1862. Bowen & Co., lith., Philada.” (Library of Congress 99447016).

The Revenue Marine turned over *Robert J. Walker* to the Coast Survey on February 11, 1848. The Coast Survey placed it under the command of Lieutenant (Commanding) Carlile P. Patterson. Patterson was a promising officer destined to become the fifth superintendent of the Coast Survey. Because during the previous month Patterson had used the schooner *Forward* for survey work in the vicinity of Mobile Bay's entrance and continued that work in *Walker*, the basis for a direct comparison of the cost of sail versus steam for surveying purposes was established. Patterson reported that for a given unit of hydrographic surveying production in offshore waters where the steamship was the primary surveying platform, it was 40 percent less costly to operate than a sailing vessel. This report helped assure the growth of the steam vessel fleet in the Coast Survey.

In its first year, *Walker* finished surveying the offshore approaches to Mobile Bay and the approaches to Cat and Ship Islands. The work accomplished by the vessel also helped to determine the somewhat unique nature of tides in the Gulf of Mexico. Because of the small range of tides in the Gulf of Mexico, coupled with the great influence of winds on the tidal levels, it was a triumph of perseverance and analysis to discern that the tides in this area were composed of only one high and one low per day as opposed to the twice daily tides of both the Atlantic and Pacific coasts. Studies of shifting channels, accreting and eroding barrier islands, and appearing and disappearing islands – all issues in the Gulf of Mexico today – were first noted in the 1848 report. In addition, the commercial significance of the survey of Mobile Bay and entrance was not lost on the mayor of Mobile: "...We trust sir, that the labors you are about to bestow upon Mobile Bay will fully confirm our present anticipations, and establish beyond controversy, the fact that our bay and harbor are capable of affording at least equal facilities with any other southern port to shipping of any description." (Appendix No. 17, 1848 Report. P. 107.) Plans were in the making for a Mobile and Ohio Railroad and, if the railroad was to be successful, it was necessary to ensure that Mobile Bay would be able to handle deep draft vessels.

June 24, 1848, marked the end of *Walker's* first season, and it returned to New York on July 29. Coast Survey's annual report gave no statistics for the cruise other than the vessel and crew had acquired 2,000 linear miles of hydrographic data. Over an 11-year period, the ship made approximately 100,000 soundings in 1848.

On January 16, 1849, Patterson and the crew went from the Schooner *Phoenix* to *Walker*. Work commenced in Mobile Bay on February 26. During this season, the ship surveyed 145 square miles in Mobile Bay, obtained 71,745 soundings, and ran 1,160 linear miles. Work ended July 3. Patterson recommended the placement of numerous buoys and fixed aids to navigation in Mobile Bay, Cat Island Harbor, and Ship Island Harbor. Notable on this cruise was the death of Passed Assistant Surgeon Silas Holmes and five men who were with him in a small boat that

capsized in a squall off Mobile on May 21. Only one man in the boat's complement lived, "sustaining himself on an oar" (*Baltimore Sun*, May 29, 1849).

In 1850, James Alden replaced Patterson as the commanding officer. *Walker* was apparently left in the Gulf of Mexico, probably at the naval base at Pensacola, and was used by another, unnamed agency (an unauthorized use according to Bache, which "deranged" plans for work in Section 8.) The ship was not ready for use by the Coast Survey until March and there were also delays caused by being unable to crew the ship. However, Alden did do a reconnaissance of Cedar Keys, Florida, and reported the existence of a shoal extending out eight or ten miles from Sea Horse Key and recommended establishing a light at the end of the shoal.

Alden completed a survey of Mobile Delta and almost completed the survey of Mobile Bay. In all, the ship and crew gathered 25,096 soundings in a shortened season with a 536 mile run in the bay. After closing work in the section, *Walker* proceeded to Key West and then to Norfolk, where the ship was turned over to S. P. Lee for work offshore of the Virginia Capes and Maryland. This was one of the few occasions when *Walker* conducted work anywhere but in Section VIII. Under Lee, *Walker* obtained 22,029 soundings in the offshore areas and 31,117 soundings by boat in bay areas. They ran 1,115 miles of soundings in outside work and 518 miles by boat in the bay. In late September, the vessel was returned to Alden.

In 1851, *Walker* was occupied with offshore work south of Dauphin Island and Petit Bois Island, in-shore work north of the same islands, and in special examinations of Pass Christian Harbor and the mouths of the Mississippi. A steam-launch, specially constructed for inshore and harbor work, was lost in a storm off the Chandeleur Islands in May. In the early part of the season, James Alden was in command and finished the survey of Bon Secours Bay, the southeast corner of Mobile Bay. After this, Benjamin F. Sands took over as commanding officer and commenced the work described above. As noted earlier, Sands would remain commanding officer of the vessel until 1858. *Walker* worked off the Mississippi Delta, where "the marshes have made out seaward, mud-lumps have been washed away, and other formed." Alden surveyed 233 miles and took 13,760 soundings, while Sands surveyed 688 miles and took 28,244 soundings. *Walker* was relegated to a repair facility at the end of the season and received new boilers. According to Benjamin Isherwood, "[d]uring the present year, the *Walker* has been refitted with new boilers at the works of Messrs. Merrick & Son, Philadelphia" (Isherwood 1852:50). This machinery remained in place for the remainder of *Walker's* life.

Following the repairs, in 1852 *Walker* continued surveying in Mississippi Sound from Dauphine Island to the longitude of Round Island including Horn Island Passage, made outside soundings (ten miles to sea) from the middle of Petit Bois Island to the middle of Horn Island, conducted a reconnaissance to the South and Southwest Passes of the Mississippi Delta, and made a survey of Naso Roads at the

north end of Chandeleur Island. They took 65,362 soundings over 1,486 miles of sounding line. Sands' executive officer this year was Charles Manigault Morris, who, during the Civil War, would be the last commander of the raider *CSS Florida*. There is no mention of whether the ship returned north or was laid up at Pensacola this season. Other notable events involving *Walker's* crew that year included the deaths of the second and third assistant engineers in a fever epidemic.

In 1853, *Walker*, under Sands' command, engaged in checking for changes to the seafloor in the vicinity of Ship Shoal, Horn Island Pass, and Chandeleur Islands at the beginning of the season in response to the Great Mobile Hurricane of 1852 (a precursor of modern work in clearing channels and checking for obstructions in the wake of every great coastal storm). The ship then began work in Mississippi Sound. The crew made 69,079 soundings over 1,430 sounding miles.

The ship was laid up in Pensacola following the 1853 season, probably sometime in June. While there, the steamer's crew was stricken during a yellow fever epidemic. The New Orleans *Daily Picayune* reported on September 17 that "the surveying steamer *Walker* was laid up for the summer with an officer and a crew of eight men to take care of her. The officer (Engineer Nones) and six men have died, so that only two remain."

In 1854, there was difficulty procuring crew so the field season did not begin until mid-March. The season began with searching for a shoal at 27° N 89° W south of the "Balize" (the east pass of the Mississippi River). Deep sea soundings and temperature measurements were made as far south as 26° 40'. Total statistics included 11,943 soundings obtained over 1,167 miles; 11,602 of those soundings were made outside of Horn and Ship Islands. The season was closed on June 1 with Sands taking *Walker* to Philadelphia for repairs and he in turn reporting to Washington for office work.

The ship apparently left Philadelphia in December 1854 and attempted to run a line of deep sea soundings from Key West to the Mississippi Passes, but poor weather made it impossible to sound in waters deeper than 250 fathoms. January 1855 ended up with a succession of gales that were repeated in February during periods of foggy and hazy weather. Work continued on the Mississippi coast and

"What is not a little curious is, that the bottle thrown overboard in latitude 28° 58', in the longitude of Mobile, where the surface temperature was 69 degrees, was found near Jupiter Inlet, on the eastern coast of Florida, having found its way to, probably by wind and counter-currents, into the comparatively warm current of the Gulf Stream."

This observation, in 1854, is perhaps the first indication of the Gulf of Mexico Loop Current. The bottle was thrown over on April 8, 78 miles south of the west end of Dauphin Island and found two months later on June 6 by a Mr. Douglas Dummet near Mosquito Inlet. The bottle had traveled over 750 miles if it had taken a straight course over the 59 days.

offshore islands and, ultimately, the year's work was the most productive of *Walker's* career with 105,591 soundings acquired over 2,319 miles of sounding line. Sands invented a bottom sampling device during this season that worked on all attempts except one, which failed when it seemingly encountered a hard rocky bottom. Sands ran soundings in the Gulf Stream while running north at the end of the season and then in October ran the section south from Nantucket, one of the more difficult sections run in the past because of its length.

In 1856, *Walker* attempted to leave Philadelphia early in the year, but was detained by ice on the Delaware River. It attempted to leave in the middle of March but the ice damaged its paddlewheels necessitating further delay at New Castle for repairs. A stormy passage south allowed for no deep-sea soundings until reaching the latitude of Cape Fear. From there, *Walker* ran soundings to Cape Canaveral. From Key West, it ran deep sea soundings north to the Mississippi Delta. *Walker* reached Pass Christian on May 1 but proceeded to Pensacola for provisions, as the weather was inclement for surveying. On May 5, operations commenced and continued until closing the season on June 11. They took 62,434 soundings during the short season, covering 1,716 miles.

Walker left Philadelphia on November 19, 1856, for the 1857 season and attempted deep-sea soundings, but poor weather in vicinity of Cape Hatteras stopped those efforts. Gales and boiler repairs at Key West delayed the arrival of *Walker* on its working grounds from Key West to Pensacola, finally departing from Pensacola on February 1. Despite the delays, *Walker* had a successful season working as far west as Bay St. Louis and then Chandeleur Sound. The ship and crew ran a line of deep sea soundings from Pass a l' Outré (the main channel into the Mississippi prior to 1860) to Key West. The deepest sounding observed was 1511 fathoms and brought up blue mud. During the working season, they obtained 75,529 soundings over 1,832 miles of sounding line. The ship then returned to Philadelphia for winter layup.

Walker left Delaware Bay on January 4, 1858, having been detained due to a shortage of officers. On January 20, 1858, *Walker's* crew, as well as that of the nearby Coast Survey steamer *Varina*, "turned to" help combat a major fire ashore at Fort Pickens while off Pensacola. The Annual Report of the Survey noted:

While detained at Pensacola, assistance was rendered by Commander Sands, with the men and boats of the steamer WALKER, on the occasion of a fire which happened at Fort Pickens on the night of the 20th of January. On the day following the accident, a communication was addressed to him by Captain John Newton, corps of U.S. engineers, commanding the harbor of Pensacola, in acknowledgment of the obligation to the officers and crew, who, in conjunction with the hydrographic party in the C.S. schooner VARINA, had promptly repaired to the scene of the disaster (Coast Survey 1857:93).

Walker's survey party commenced work in Atchafalaya Bay on February 6. In March, *Walker* conducted a hydrographic examination of the western end of Lake Borgne, with an additional 2,152 soundings and over 37 miles of lines. Near the end of the season, *Walker* proceeded on a line of deep sea soundings from Southwest Pass to the Tortugas. The deepest sounding ever obtained *Walker* on this line was at 1710 fathoms. The season ended on May 3, by which time the crew had obtained 75,951 soundings over 1,117 sounding miles. *Walker* arrived in Philadelphia in early June. Commander B. F. Sands was detached and Lieut. Cmdg. Thomas B. Huger became the next commanding officer of *Walker* in September 1858 (Coast Survey 1858:106).

Under Huger's command, in 1859 *Walker* arrived on the west coast of Florida in early January and conducted an investigation of the channel into Cedar Key, Florida, with the crew making 15,102 soundings over a 166-mile run. *Walker* then proceeded to Pensacola for provisioning and departed for Atchafalaya Bay on January 15, 1859. On that run, 69,447 soundings were observed over 743 sounding miles. During the survey work, *Walker* was primarily used as a hotel ship because of shallow waters in the working area. The ship conducted deep-sea soundings on the trip south to Key West and then ran a section of Gulf Stream from the Tortugas to Havana while on the way north. In Philadelphia, Lt. Cmdg. John Julius Guthrie was assigned as *Walker's* commanding officer on October 10, 1859. He had served in the Navy continuously since 1834.

Walker's 1860 season began on January 20 in the Cedar Key, Florida, area where it conducted a thorough examination on its way to the Gulf. Work there finished in mid-February after obtaining 41,811 soundings over 467 miles run. The work on the Louisiana coast included 13,072 soundings (acquired over 244 miles) in Chandeleur Sound, and 34,916 soundings (acquired over 612 miles) on the Mississippi Passes. Both Chandeleur Sound records and Mississippi Passes records were lost in the sinking of *Walker*. Upon return to the Northeast in June, *Walker* stopped at Norfolk and thence planned to continue on to New York although the vessel was sunk on the night of June 21, 1860.

The Accident

(with contributions from Albert Theberge and Dawn Forsythe)

On June 21, 1860, *Walker*, with 72 on board (71 crew and the wife of executive officer Joseph Seawell), was lost at sea as the result of a collision with the 250-ton schooner *Fanny*, bound from Philadelphia to Boston with 240 tons of coal and running close-reefed before a gale (Vincent 1860:560-561). The executive officer, Joseph A. Seawell, was the officer on watch at the time of the collision. Seawell was a naval veteran, but had been dismissed from the Navy on the recommendation of the Efficiency Board in 1855. Twenty men died in this accident, making it the worst

single disaster to strike the Coast Survey. To this day, it remains the single greatest loss of life suffered by NOAA or a predecessor agency of NOAA.

The New York *Herald* of June 23, 1860 printed the account of the Quartermaster, Charles Clifford:

At the time of the collision Lieutenant J. A. Sewall [sic], the executive officer, was on watch. It was about quarter-past two in the morning. We saw the schooner ahead, coming before the wind, and put the helm hard aport to clear her. The schooner was close aboard of us. The lights of both vessels were burning clear. The atmosphere was cloudy, and the wind blowing fresh from the northeast. The schooner thereupon put her helm hard astarboard, which made a collision inevitable. She struck the steamer forward of the port guard and wheelhouse, cutting her down to the water's edge, and carried away her own head booms. The schooner hung for a moment, then swung alongside, and carried away the forward and quarter boats of the steamer. Getting clear of the schooner, we worked ahead, but found the Walker was sinking; cut away her mainmast, booms, and got everything movable on deck, to make a raft for the men. Everybody cool, and the officers behaving with great presence of mind, lowered both starboard boats and dropped them astern for use when the vessel went down. By this time every soul was on deck except those who may have been killed or injured by the collision, and a sick man on board, nearly seventy years of age, almost helpless, had been carefully lifted out and put in one of the boats. All was orderly. The men stayed by the steamer until she was sinking, and then, without confusion, such of them as could took to the boats. Many of the crew went down with the steamer, however, clinging to the spars and portions of the wreck, and expected to be saved in that way. The captain stayed on board until the steamer went down, and just before she disappeared from sight jumped into the water, and was picked up by one of the boats. Lieutenant Sewall was drawn down in the vortex, and, after remaining for a considerable time floating on a portion of the wreck, was also rescued by one of the boats. A heavy sea was running, and many of the men were doubtless washed off the spars and drowned from the mere exhaustion of holding on, while others were killed or stunned on rising to the surface by concussion with spars and other parts of the wreck. The steamer had entirely sunk from sight in thirty minutes after the collision. Many of the crew were rescued by the boats, in which were about forty-four persons, and they were in turn picked up by the schooner *R.G. Porter*, Captain S.S. Hudson. He did nobly, keeping his vessel about the spot where the wreck went down until two o'clock in the day, and using every endeavor to render us comfortable and afford the desired assistance. Finding that it was useless to remain longer in searching

for the missing, Captain Hudson stood into Cape May, where he arrived about four o'clock on Thursday afternoon.

The above account is corroborated in all particulars by that of Lieutenant Commanding J.J. Guthrie, United States Navy, with whom another of our reporters likewise had an interview at a later hour in the evening. He states, in addition to the above, that on arriving at Cape May a schooner was there with a rent in her foresail, her head spars carried away and her cutwater injured.

The name of this vessel was the *Fanny*, and the time of her arrival was such as to make it almost certain that she was the author of the accident. While in Cape May the officers and crew were provided with much needed refreshments and clothing by the citizens. Prominent among those who rendered assistance were Mr. West, the proprietor of Congress Hall, J. C. Little, of Our House; Captain Johnson, of the steamer *Kennebec*, and Captain Cannon, of the *Delaware*, and Messrs T. M. Quicksall and J. W. Burton, of Philadelphia. Lieutenant Guthrie speaks in the highest terms of the conduct of the crew under the trying circumstances, and states that when the steamer went down every man was at his post, there being in the boats only three individuals and a dog. A heavy gale was blowing at the time and a rough sea running, which caused the steamer to careen and settle much more rapidly than she otherwise would have done, as well as prevented those engaged in the work of rescue from saving all those who were enabled for a time to keep themselves above water. It is hoped that as a number of schooners were in the vicinity others may have been picked up, and, indeed from the maneuvers of one of them, the captain states that it is almost certain that such is the case. The survivors who came on to this city have reported themselves to the Commandant of the Navy Yard, and been paid off. All are in a destitute condition, however, officers and crew having lost everything except the clothes on their backs. In view of these circumstances, and the bravery and discipline manifested on the trying occasion, it behooves government to take some steps to recompense them for their loss.

Captain Mayhew of *Fanny* indicated that his vessel's bow had struck with considerable force, and that it was his opinion that his bow anchor, catted forward, had opened up the plates of *Walker's* hull. With considerable damage, and thinking *Walker* was in no danger, he had proceeded on to Cape May (Vincent 1860:560-561).

Superintendent Bache referred to this tragedy in only three separate paragraphs in his 1860 Annual Report; perhaps he found it too painful to deal with, or maybe the events overtaking the country overwhelmed all else in 1860 and 1861. With the approaching Civil War, there was never an inquiry concerning the causes of this

accident and the assignment of responsibility for its consequences. Surprisingly, Superintendent Bache never printed a listing of names of the deceased crewmen. The contemporary newspapers carried accounts of the sinking and the names of the crew. The story published in the *New York Times* on June 23, 1862 provides the most comprehensive accounting of the crew, and then who was lost:

Mr. Guthrie, son of Lieut. Guthrie, in charge of the crew. John McMullen, Captain main-top. John Burton, master-at-arms. Charles Clifford, John Brown, J.R. Hall, Essex D. Corcoran, (sick and unable to report himself,) Quartermasters. Robert Bell, Joseph Meary, George Penn, Joseph Peterson, John Desmond, John Rowe, Joseph Clark, John Brien, Andrew Young, William Logan, William J. Jones, John Smith, James A. Golden, seamen. James Clark, James Delorse, Alonzo Hood, John A. Minor, John W. Walsh, Burnett Canah, ordinary seamen. John C. Johnson, boatman's mate. James Young, gunner's mate. Edward Lynch, arms mate. Joseph Wilson, sailmaker. John Taylor, firemen. Michael Lyons, Daniel Evans, Frederick Dougherty, Henry Hunter, Michael Boyle, coal passers. Peter Decker, (boy.) John Harrison, C.T. Thomas Rixley, Lds. William H. Mapes, 1st C.F. Henry Dick, S.S.

There were three others known to have arrived in the steamer, making forty-four in all who are saved.

LIST OF THE MISSING.

The following list of the missing crew has been supplied by Mr. CHARLES GIFFORD, Quartermaster on board of the Walker, to whom we are also indebted for the particulars of the collision:

Marcus (or Marquis) Buoneventa, ward-room steward.
 Michael M. Lee, ship's cook, (colored.)
 James Patterson, ward-room cook, (colored.)
 Henry Reed, second mate.
 Timothy O'Connor, sacond gunner.
 John Driscoll, seaman.
 Michael Oلمان, seaman.
 George W. Johnson, son of Mr. Johnson, the actor.
 Charles Miller, ordinary seaman.
 Robert Wilson, seaman.
 John M. Brown, captain of after guard.
 Jeremiah Coffee, cooper.
 Cornelius Crow, landsman.
 John Farren, fireman.
 James Farren, fireman.
 Samuel Sizer, fireman.

George Price, fireman.
 Joseph Bache, fireman.
 Daniel Smith, fireman.
 Peter Conway, fireman.

Total 20.

RECAPITULATION.

Names of those saved.....44
 Names of those missing.....26
 Total of the crew.....64

The foregoing list corresponds with the names of the lost as telegraphed from May's Landing, N.J., and signed by N.G. PORTER, but afterwards the following names are added:

S.J. HUDSON.
 JOHN ENGLISH.
 E. SMITH.
 WM. TAYLOR.

The Annual Report of the Coast Survey did not focus on the human loss, but rather the impact on the Survey itself, and included these observations, appearing at different places in the report:

The progress of the work has been, taking all its branches together, greater than during the year before, but the loss of one of our best steamers by collision at sea has been a sad drawback to the general prosperity of the work. As my estimates for the time of completion of the survey must be materially affected by this loss, I earnestly recommend a special appropriation to replace the steamer at the earliest practicable period.

The loss of the steamer *Walker*, by collision at sea, requires an appropriation to replace her. As the government acts as its own insurer, this is an indispensable item of estimate. The loss of a considerable part of the records of last season's work, and the loss of time from having no steamer to take the *Walker's* place in the Gulf of Mexico, will be sensibly felt in our progress, and I would respectfully urge that another steamer be supplied at the earliest practicable period, so as to enable us to work up again as soon as possible to the former efficiency.

I have elsewhere referred to the wreck of the steamer *Walker*, on the 21st of June of the present year. This disaster, which involved loss of life to twenty of her crew, with the total loss of the vessel and all the records on board, was occasioned by collision with a schooner laden with coal, and occurred about three o'clock in the morning, while the *Walker* was off Absecom [today spelled Absecon], New Jersey, in

command of Lieutenant J. J. Guthrie, U. S. N., and on her passage from Norfolk to New York. The officers of the *Walker* and survivors of her crew were rescued from imminent peril by Captain L. J. Hudson, [referred to as Captain S. S. Hudson in most accounts] of the schooner *R. G. Porter*, and safely conveyed to May's Landing, on the coast of New Jersey. The steamer sunk in less than half an hour after the collision, which took place about twelve miles from land (Bache 1861:1,10.44).

Other contemporary reports indicated that after Superintendent Bache received a telegram on June 21, notifying him that the *Walker* had sunk and twenty of the crew were missing, he immediately wrote to Guthrie, asking him to report the circumstances of the disaster. Guthrie wrote Superintendent Bache on June 23:

It becomes my painful duty to report to you the loss of the U.S. Coast Survey Steamer "Walker" which was sunk at sea in five fathoms of water about six miles SE of "Absecum [sic] Light" on the coast of New Jersey, in consequence of being run into by a schooner - supposed to be the "Fanny" on the morning of the 21st of this month about 2:20 A.M... Two of the boats were stove in and rendered useless by the collision, the two remaining ones were lowered, and many of the crew saved by this means, and the timely assistance of the "R. G. Porter" of Mays Landing, N. J., Capt. S. S. Hudson, who came to our assistance in this hour of need... I cannot withhold... profound regret for the melancholy fate of that portion of the crew who are still missing and who it is to be feared have found a watery grave. During this sad catastrophe the sea was running high and the wind very fresh... I need not add that the loss of my own professional reputation, necessarily incident to such an accident occasioned very slight regrets compared to the depths of sorrow I endure for the missing - and heartfelt sympathy entertained for the anxious and bereaved families and friends - I am sure you understand the workings of the heart sufficiently to render it unnecessary for me to essay to unfold mine in written terms...

Lieutenant Guthrie finished his letter with a request for Superintendent Bache to notify the Secretary of the Navy and "obtain for me a court of inquiry and investigation." Bache replied to this letter on June 25: "I have telegraphed to request a detailed report of the circumstances of the disaster to the 'Walker' as the one now made gives no idea of the facts of the case..."

Guthrie responded with additional detail:

... On the night of the 21st about 2:20 A.M., I was awakened by an unusual noise on deck, and my first thought was that the 1st officer was getting a cast of the lead, but soon after heard the Executive Officer tell someone to call the Captain - an officer came down and

reported to me that the vessel was sinking – I went on deck and directed her to be headed inshore, and to give her all the steam speed possible, seeing Absecum Light distinctly – being about West – Nor. West – distant about nine miles... A schooner was near us, which I hailed and requested to keep by as we were sinking – soon after this the engineer reported the fires extinguished – and the water gaining very rapidly on us – I had previously sent men down in the coal bunkers to see if the leak could be stopped in any possible way – it was found to be impracticable – finding she must inevitably go down soon – I directed the mainmast to be cut away – the boats to be lowered and some of the ladders to be towed astern for buoys – and also directed the quartermaster to get a cast of the lead – he reported five fathoms water – Soon after she sunk. It was found two of the boats had been crushed... the two remaining ones picked up what portion of the crew they thought they could carry in safety; Nothing was saved, except what was on and about the persons of those who were rescued – all the Note Books, Instruments, charts of the vessel etc. went down with her and as all the records are gone – I have to depend upon memory for the facts – all of which it is impossible to remember distinctly...

Lieutenant Guthrie thought that the steamer might be raised or that the engines and machinery could be recovered. Guthrie was mistaken. The steamer had sunk in approximately 13 fathoms instead of the 5 fathoms that Guthrie initially thought, and was now thought to be about 12 miles offshore instead of the 5 to 6 miles reported. If there is any criticism of Guthrie, it is that he had no idea where his ship was when it was struck and also that he was not awake and on deck as his vessel had just passed the busy entrance to Delaware Bay and would be approaching progressively more congested waters as it approached New York City.

Lieutenant Guthrie's second letter seemed to appease Superintendent Bache. Bache wrote back on July 6, "If your desk could be procured containing the papers of the survey, it would be worth \$2500 and if the engines or parts of it can be had it would help us materially." Bache also advised Guthrie "to consult the District Attorney, for which I will pay, as to the propriety of libeling the Sch. *Fanny*, making in conjunction with Mr. Seawell's statement of facts to him upon which he will ground his opinion." After Superintendent Bache's allusion to "libeling" the *Fanny*, there seemed to be little additional effort to conduct an investigation into the causes of the accident or the placing of blame. The advent of the Civil War pushed the affair out of the way, although some, including family, never forgot. A chronicle of coastal events noted in 1881:

In June, 1860, about three A.M., as Captain Sheppard S. Hudson, from Mays Landing, of the schooner *R.G. Porter*, was running before a gale off Absecon beach, he was startled by appalling cries of distress from drowning men, struggling the waves all around him. The United

States Revenue [sic] Steam Cutter “Walker” had been sunk a few minutes previously by collision with the schooner *Fanny*. Captain Hudson, with great labor and risk to his own vessel, remained until he had rescued fifty-one out of seventy-one persons, and for this noble deed he has to this day received no token of regard, not even the thanks of our own Government (Brown 1881:62).

The career and fate of the last captain of *Robert J. Walker* is important to note. John Julius Guthrie (1815-1877) was born in Washington, North Carolina. He received an appointment to West Point but after a year transferred to the U.S. Navy and served aboard USS *John Adams* before transferring to the USS *Columbia* in 1838, where he served until 1842. Guthrie was an officer of great character and promise, and in 1842 was promoted to lieutenant and attached to the Sloop-of-War USS *Warren*. He then served on the USS *Union* (1844), the U.S. Schooner *On-Ka-Hy-e* (1845-1846), and the U.S. Schooner *Flirt* (1846), with the Home Squadron during the blockade of Veracruz during the Mexican War. Guthrie then joined the crew of USS *Brandywine* (1847-1850). He also served on USS *Saranac* (1852-1853), and USS *Levant* (1855-1858).

While on USS *Levant* in the Far East, Guthrie captured a Chinese flag while fighting ashore when the U.S. briefly intervened in the Second Opium War and sent ships to protect U.S. lives and property. After a brief landing at Canton, which was unopposed and without incident, the retreating U.S. boats were fired upon. In retaliation, *Levant*, USS *San Jacinto* and USS *Portsmouth* attacked and silenced the Chinese forts protecting the entrance of the Pearl River, with landing parties encountering fierce resistance when they took the forts and spiked the guns. The U.S. suffered a loss of ten dead and 32 wounded, while the Chinese lost hundreds. Guthrie’s bravery under fire and his capture of the flag attracted favorable attention, especially in his home state of North Carolina.

Guthrie’s service also included time with the U.S. Naval Observatory in Washington, D.C. as a hydrographer, and with the Coast Survey, when he commanded *Walker*. Following his time on *Walker*, in which his 17-year-old son, John J. Guthrie, Jr., was a member of the crew (and survived), John Julius Guthrie was attached to the USS *Saratoga* as its executive officer on anti-piracy patrol. On April 21, 1861, as the Civil War commenced back at home, *Saratoga* captured an American slaver, the clipper *Nightingale* of Boston, off Kabenda Bay, forty miles north of the Congo on the west coast of Africa, and freed 961 slaves, landing them in Liberia. This was the last capture of a slaver by the United States’ African Squadron.



John Julius Guthrie (National Civil War Naval Museum 1999.0050.0002)

When *Saratoga* returned home to Brooklyn Navy Yard, the war was underway, and Guthrie resigned his commission in the U.S. Navy on July 6, 1861. On July 13, he was appointed a 1st lieutenant in the Confederate States Navy. He served as commander of a floating battery at Island No. 10 on the Mississippi, and then briefly as the second commanding officer of the ironclad CSS *Chatahoochee*. *Chatahoochee* was disabled by a boiler explosion during Guthrie's command, and his colleagues later criticized his actions following the accident, when he came on deck and instead of taking command decided instead to bless and administer the final rites to his dead or dying crew. Guthrie went on to a successful career as commanding officer of the government-owned blockade runner *Advance*, but was not on board when the steamer was captured in 1864. In 1865, back in his native North Carolina at war's end, Guthrie applied for and received a pardon from the U.S. Government as a former Confederate officer.

In 1875, Guthrie returned to public service as the newly appointed Superintendent of the U.S. Life Saving Service's Sixth Life-Saving District for stations just being built on the Outer Banks. On November 24, 1877, the USS *Huron*, en route to the Caribbean, stranded in the surf off Nag's Head and began to batter apart with 132 officers and crew. Hearing of the disaster, Guthrie joined the steamer *B & J Baker*, attempting to arrive in time to rescue as many as they could from the wreck. On the morning of November 25, they reached the wreck in heavy seas and launched a boat to reach shore and make contact with the survivors. The boat was caught in a heavy swell and capsized, killing Capt. Guthrie and four of the steamer's crew. In all, 102 people died, 98 of them *Huron's* crew (Stick 1981:83). The ocean that had not claimed John Julius Guthrie when *Walker* sank on June 21, 1860, finally took him seventeen years later.

Remote Sensing Survey (Pradith and Steinmetz)

While the general location of *Robert J. Walker*'s loss was known, the wreck was not relocated or salvaged, and an 1864 chart of the area does not mark it.

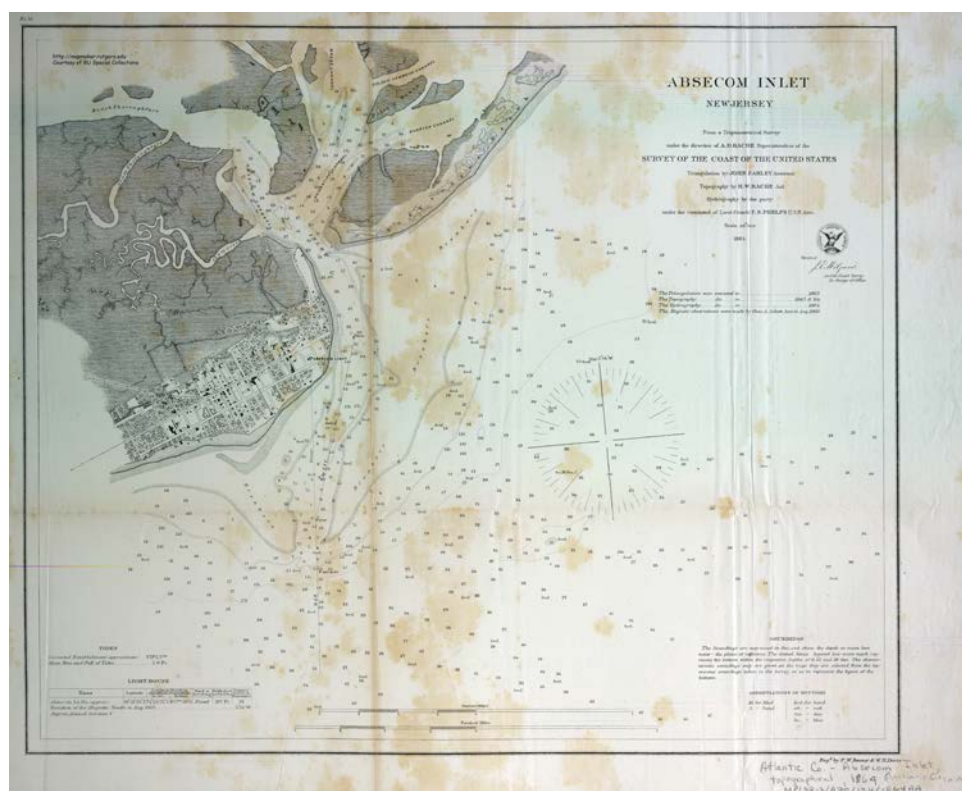

“Absecom Inlet, New Jersey,” 1864 (Rutgers University Special Collections)

The wreck site has never been charted as a wreck, but in time became known to local captains and divers. Steinmetz notes that the wreck may have been wire-dragged during World War II (Steinmetz 2013).

A review of Chart 1108-A, a classified WWII chart, shows eight ship wrecks within a radius of approximately 10 miles from the site of the *Walker* (most inshore). The closest to the position below is that of an unknown wreck located at 39 14 45 N and 74 23 00 W. This wreck was wire-dragged and cleared to a depth of 38 feet. The wrecks discovered in the vicinity are noted as items 595 to 601 and 233. Because of the relative proximity to shore, those wrecks listed as wire-dragged by the Coast Survey probably have navigational errors of less than a $\frac{1}{4}$ mile and possibly significantly better. The navigation would probably have been by 3-point visual fix on known objects on land (www.photolib.noaa.gov/big5/cgs05499.jpg).

The charted obstructions in the area include the target wreck and others in an area of shoals. The AWOIS (Automated Wreck and Obstruction Information System) record for the site states it is an unknown wreck/obstruction and notes:

178 ANTHONY VRAIM, DIVERS; OBSERVED SUNKEN WWI
FREIGHTER; LORAN-C
9960-X-26929.10, 9960-Y-42939.30 (ASF CORRECTED) POS.39-13-
28.5N,74-17-17.25W.

Multibeam sonar data acquired by NOAA in 2004 roughly defined a wreck that was approximately 40 meters (134 feet) in length, and while it did not appear completely intact, it did appear to be articulated – i.e. the bow, and stern more or less line up with the midships section. While the dimensions of the 2004 multibeam sonar image correlated closely to the *Walker's* historically reported dimensions, the project sought to determine whether there were other shipwrecks in the vicinity. This data was correlated by Vitad Pradith, who used reports provided by Joyce Steinmetz. Steinmetz's data was culled from fishermens' and divers' database locations from her dissertation fieldwork. The information helped define a search area for an updated multibeam survey with higher resolution equipment than that available in 2004.

The NOAA ship *Thomas Jefferson*, working in the area on Hurricane Sandy-related surveys, was detailed to spend a day surveying the area believed to be where *Walker* sank. The survey area was selected based on Bache's published statement in the Coast Survey annual report that the wreck was 12 miles southeast of Absecon Light. The basis for Bache's determination is unsure, but it is assumed that it was based on the reports of Guthrie and Seawell.

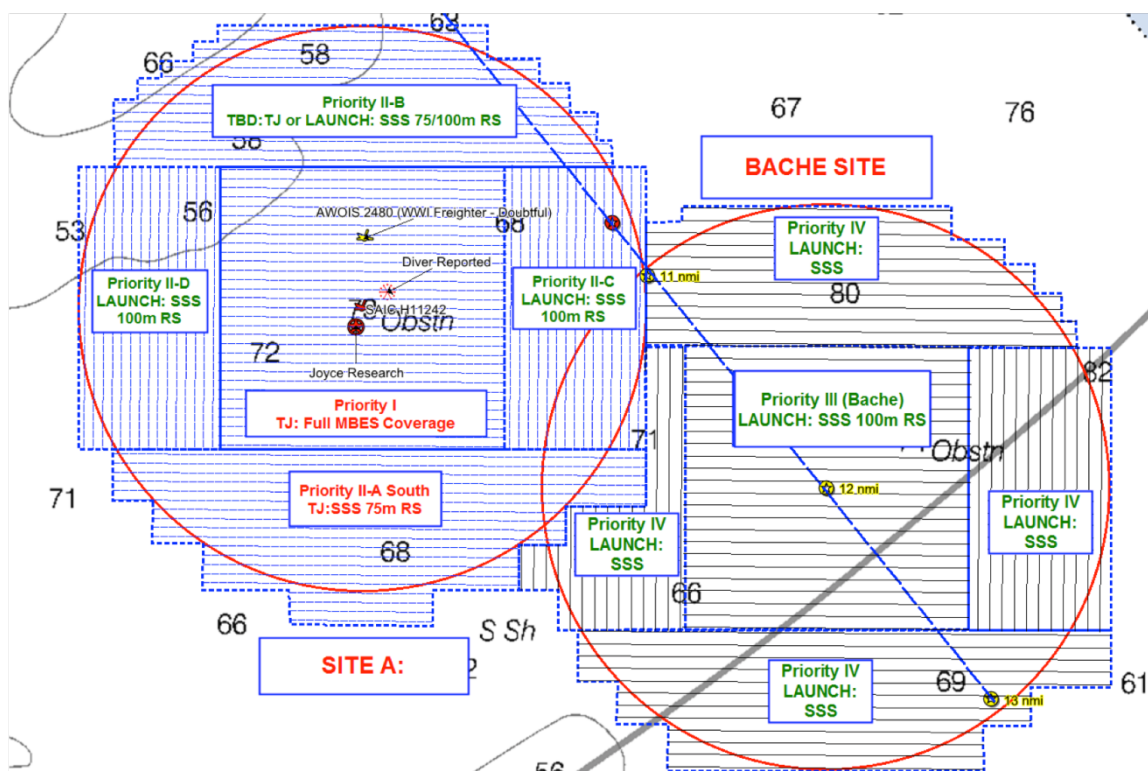

2013 Survey Area

Pradith plotted the true SE bearing in 1860, using the NOAA National Geophysical Data Center's magnetic field declination webpage (www.ngdc.noaa.gov/geomag/web/#ushistoric) and geo-referenced the historic 1880 chart to the 2010 chart, utilizing the latitude/longitude grid on the perimeter of the charts.

Given the probability that Site A was *Walker*, based on diver observations and the 2004 multibeam image, high resolution scanning of Site A was the top priority. Using the 2004 survey position as an origin, the survey plan created concentric one-mile and two-mile diameter search areas. Steinmetz's research number was from a compiled commercial fishermen's hang database. These snag locations are recorded in the fisherman's pilothouse; the actual snag location would be the length of the fishing vessel from the GPS antenna to the snag on the sea bottom. This offset will vary with each length of fishing vessel and length of fishing gear. The fisherman's wreck location and the 2004 survey location are 400 feet apart, almost parallel to the now defunct Loran grid lines, sometimes used by fishermen on autopilot to run bottom-fishing operations.

After adjusting for true SE in 1860, that location was used as an origin for concentric one-mile and two-mile diameter search areas. This area was titled the Bache area. The distance between the Site A location to the Bache location is 1.7 nautical miles. Had the team not had knowledge of Site A from the sport diving and commercial fishing community, it would have taken a 4 nm diameter search area on the Bache position to find Site A; greatly increasing the survey time and resources. To the diver and fishermen's locations, Pradith added AWOIS locations and plotted over the survey areas. This resulted in two major clusters, one at Site A and another just east of Bache's location, with three outlier hang positions from Steinmetz's research. This was an expected and welcomed result.

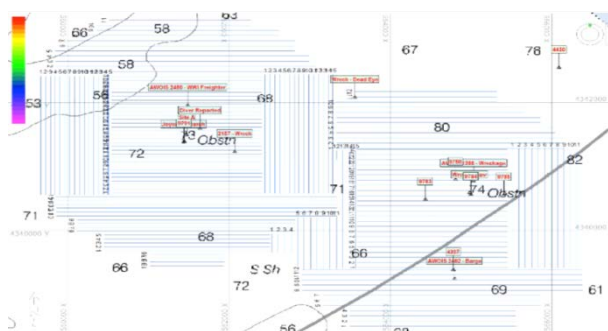

2013 Site Survey “Clusters”

The survey plan was to ensonify the survey area with a high frequency (400kHz) 0.5 x 1 degree multibeam echo sounder that would provide the science team with full bathymetric coverage of the seafloor. Target resolution (i.e. the ability to discern discrete objects) is dependent on various factors (e.g. range, angle, acoustic pulse length, and oceanographic conditions) but is conservatively estimated to be 30 millimeters (mm) based on previous experiences. The science team anticipated the ability to discern bathymetric features at a 30 mm resolution for this particular sensor. This represented an four-fold improvement in sensitivity over the 2004 data.

The multibeam data was to be acquired at an opening swath angle of +/- 60 degrees to ensure high resolution detection using narrow beam widths with a bias toward amplitude detection. Additionally, minimal pulse lengths and power settings were monitored to avoid oversaturation of the sonar. The post processing methodology was to reduce swath angles to +/- 45 degrees, and then apply attitude, sound speed, and water level corrections. NOAA hydrographers towed a 500 kHz high resolution side scan sonar simultaneously with the multibeam mapping operations to acquire side scan sonar imagery. Both sensors were coupled with a GPS-aided inertial navigation sensor to provide high accuracy positioning and motion compensation.

Key aspects to be examined included the wreck's orientation and placement in relationship to the nearby shoal. Key questions were:

1. Does the sonar indicate the level of structural intactness for the vessel?
2. What are the dimensions?
3. Is there evidence of dragging or displacement of structure?
4. Is the vessel in its original (sinking) orientation?
5. Is the vessel oriented in a position to be heading for shore?

The survey took place on June 21, 2013, the 153rd anniversary of *Robert J. Walker's* loss, following a shipboard memorial service and the lowering of a memorial wreath into the sea.

The side scan sonar was set to a 75 meter range scale and the multibeam echo sounder provided 100% full coverage, to match the objective of the survey to find the target of interest. This data should not be used for navigation. If significant features were found, the survey crew developed the feature with multibeam immediately. Data processing occurred aboard *Thomas Jefferson* close to real-time.

The outer ring of Site A and the Bache 1 nm diameter area did not contain any *Walker*-like vessels. In the Bache inner area, the only feature appears to be a spoil site of 90' length by 58' width by 6' height.

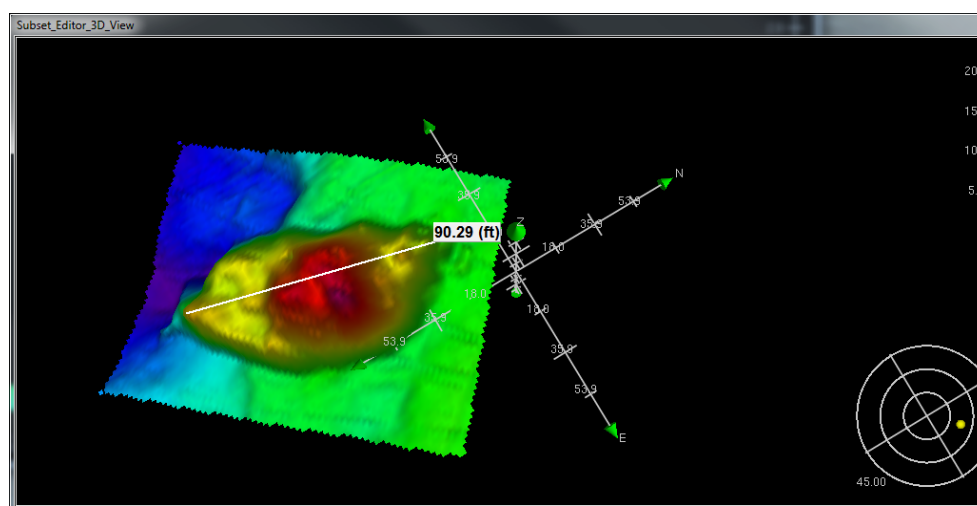

3D visualization of the feature found in the Bache area, measuring 90' in length. It resembles a spoil-like area with the characteristics of a loose aggregate, such as coal or stone.

For future study, in the south end of the outer Bache area, which was not surveyed this trip, AWOIS lists a sunken barge, which may be related to the feature.

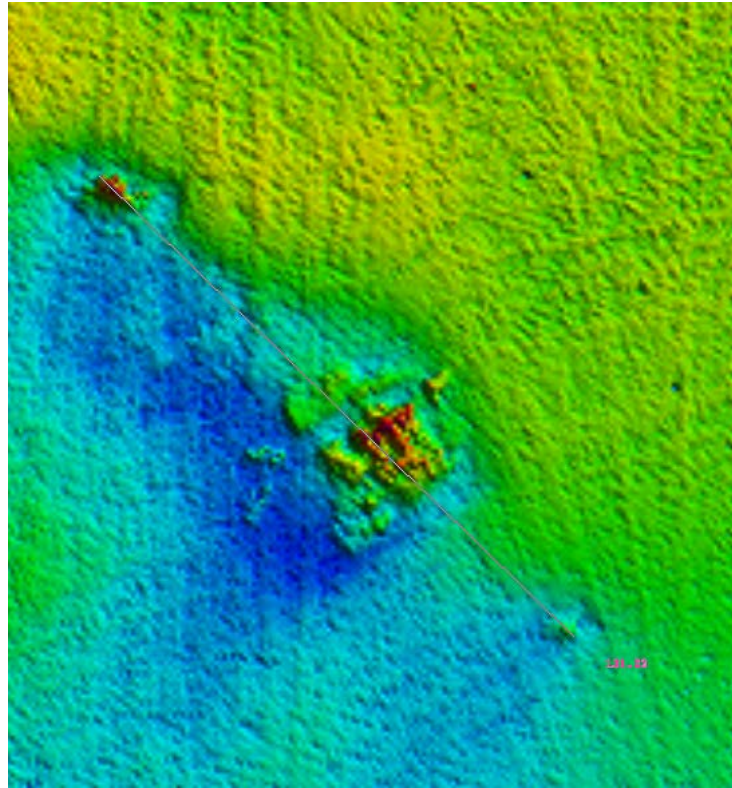

Site A, with the length of the wreck measured

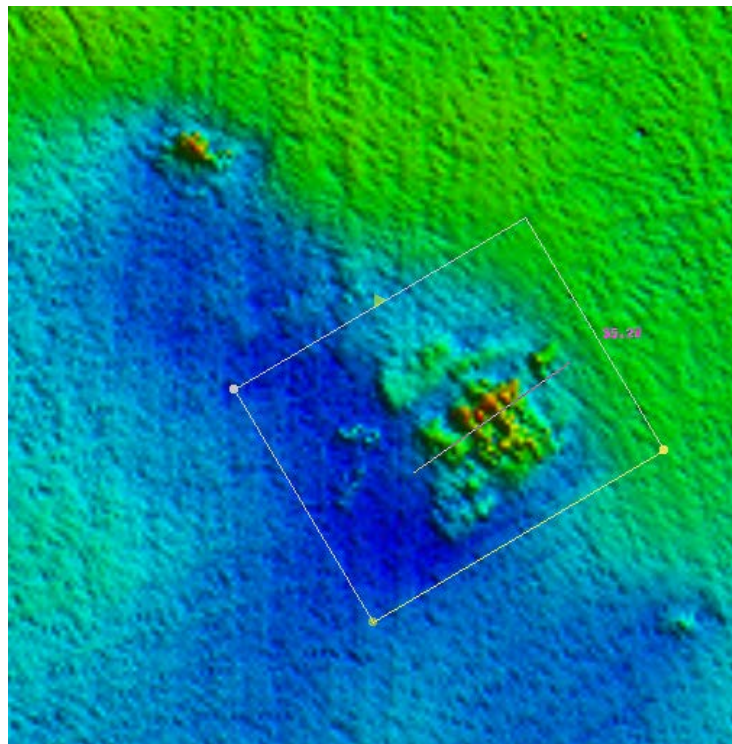

Site A with the maximum width of the wreck

Site A, the only shipwreck located in the survey area, matched a number of key characteristics for *Robert J. Walker*. The higher resolution sonar allowed for discrete mapping and measurement of features such as length, which was defined at 131 feet.

- 1) The wreck site is within 1.7 nm of Bache's historical location.
- 2) The vessel heading, headed northwest towards shore and Absecon Inlet.
- 3) The vessel type, based on the observation of shaft-like structures spanning top of the engine, indicated the wreck was a sidewheel steamer.
- 4) The boiler/engine configuration, with twin engines aft of a mass indicative of boiler placement.
- 5) The vessel length, 131 feet, closely matched *Walker's* length. The maximum width of 35.22 feet was approximate for *Walker* when sidewheel widths were added, i.e. 24 feet, 6 inches + 12 feet = 38 feet, 6 inches. The port sidewheel appeared to be partially missing in the sonar, which might account for the three-foot difference.
- 6) The structure assumed to be a boiler or boilers had a width or length of 15.99 feet, and *Walker's* boilers were 15 feet, 2 inches in length.
- 7) The one clearly visible paddle wheel hub width, as measured by sonar, was six feet, which matched the reported width of *Walker's* sidewheels.

With the sonar survey completed, and with an indication that Site A likely represented the wreck of *Robert J. Walker*, the next phase of diving observations, documentation and recording commenced on June 22-23. The sonar survey results and the coordinates for the wreck were then relayed to the Office of National Marine Sanctuaries Research Vessel *SRVx*, which was en route to New York in response to a request to locate the Hurricane Sandy toppled remains of an historic lighthouse swept off its base and into Long Island Sound.

The *SRVx* crew, joined by a Maritime Heritage Program team of Tane Casserley, Russ Green, and Matthew Lawrence, ONMS Director Daniel Basta, and USS *Monitor* NMS Superintendent David Alberg, and working under the direction of Chief Scientist and ONMS Maritime Heritage Director James Delgado, conducted a day and a half of systematic dives to 85 feet to study, measure and photograph the wreck in an effort to identify it, and to assess its condition. Vitad Pradith joined the *SRVx* team, as did Office of General Counsel Intern Lydia Barbash-Riley, who was tasked with preparing the draft Environmental Assessment for the site if it was identified as *Robert J. Walker*. *SRVx* was commanded by Pasquale DeRosa and crewed by Steve Bawks and Todd Recicar.

Work began with an additional high frequency (900 kHz) side scan sonar survey of the site. This side-scan sonar survey was run with slow, close spacing to better qualify

features on the site, which included the bow and the machinery. Because of the slow speed and current, some of the images have distortion; nonetheless, key features were readily identifiable and a more discrete sense of the site was obtained.

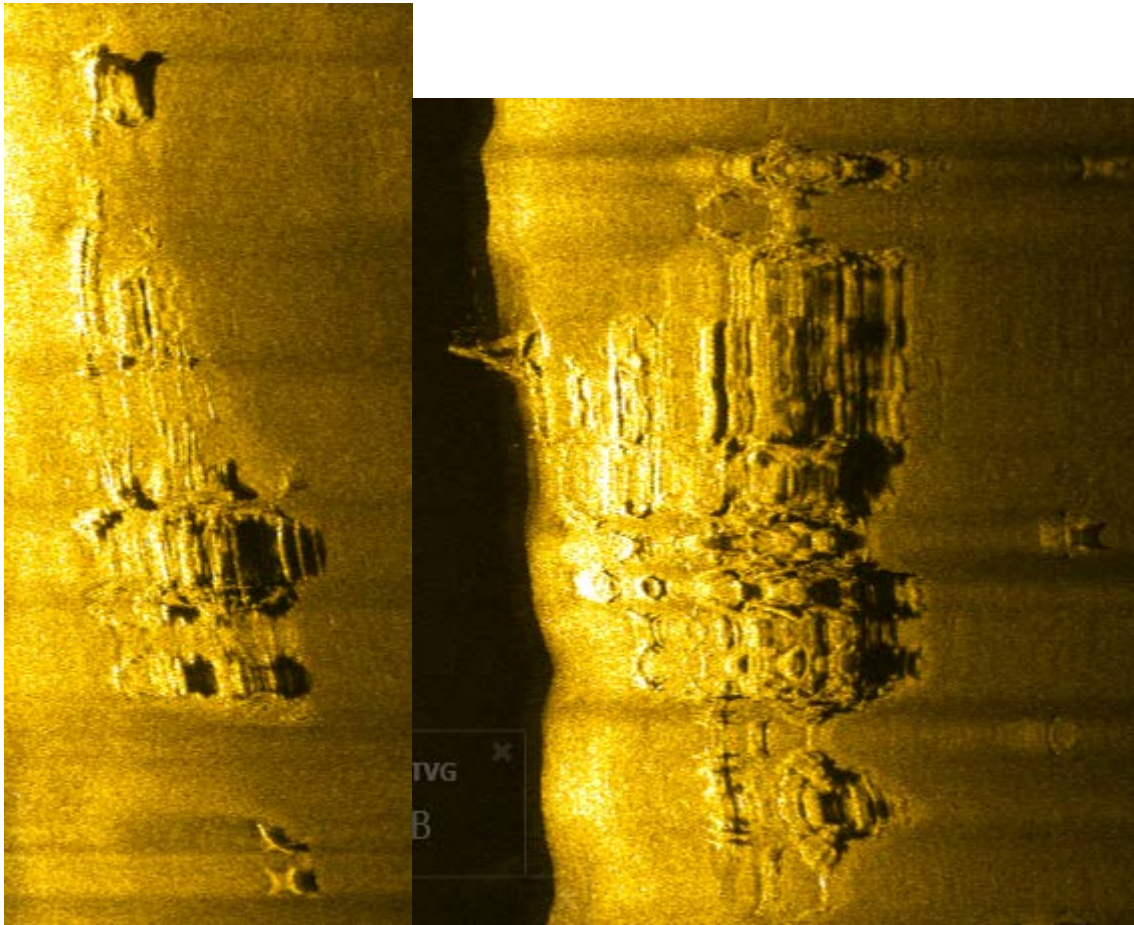

In the left image, the bow is visible at the top of the picture, and the starboard side of the hull is visible emerging from the sediment. Sand or mud has mounded and obscured the port bow. Toward the bottom of the picture, a mass of machinery is visible, with structure rising above the seabed behind it. In the right image, the central machinery area is defined, despite distortion at the top of the picture, as two engines linked to a paddlewheel shaft with an upright wheel on the port side, and the hubs of the starboard wheel bare on the shaft, but with what may be sidewheel parts lying aft of the hub. The shadow of the port engine indicates a cylinder lying low and horizontally in the hull.

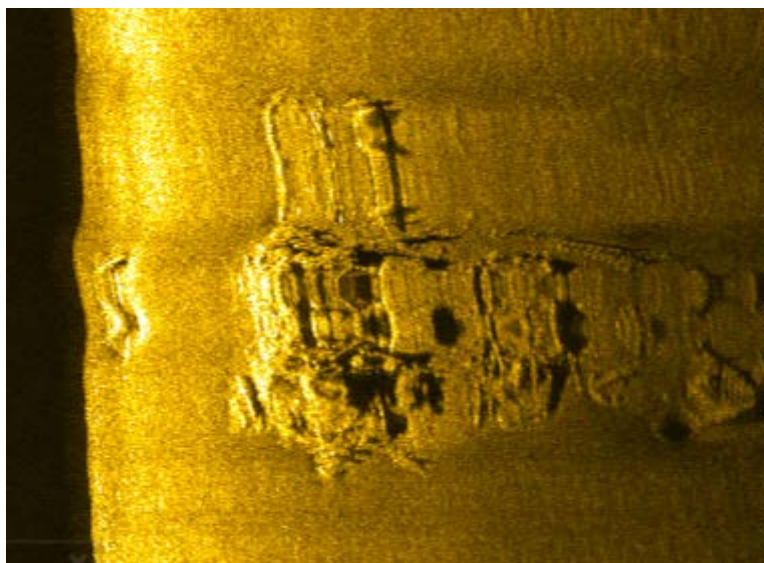

In this acrosstrack side-scan sonar image, the bow is visible to the right, displaced from the centerline and upright, with an exposed anchor lying aft of it. The starboard side of the hull is visible with lines of frames, curving aft to the starboard paddlewheel shaft and hub of the wheel. Inboard (and below) of the shaft and hub is the machinery space, with the engines and the probable remains of the boilers. As the multibeam sonar also showed, sediment is encroaching on the wreck along the portside. There are vessel remains and structure lying inside the hull between the machinery and the bow.

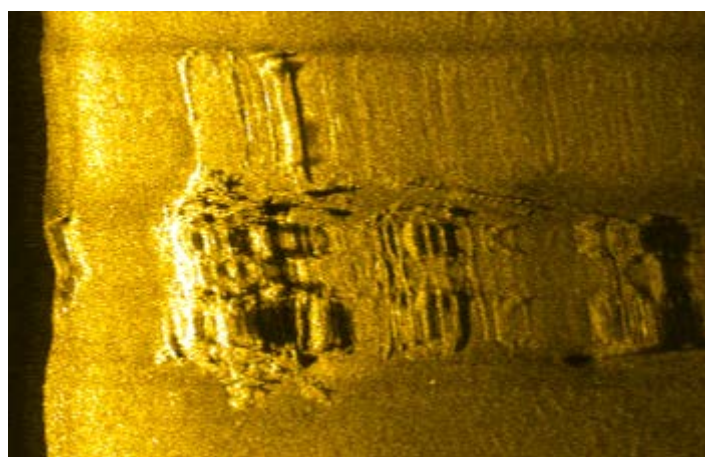

In this acrosstrack view, the hull structure along the starboard side is better defined, and the vessel structure lying between the machinery and the bow is linear and suggestive of the boilers. The construction contract for *Robert J. Walker* noted that the hull plates were eight feet in length and $5/16^{\text{th}}$ of an inch thick, double and single riveted with $10/16^{\text{th}}$ of an inch headed rivets. The frames (ribs) were 10-lb. T-bar. The beams were 15-lb. T-bar. The ship had watertight bulkheads and coal bunkers made with $3/16^{\text{th}}$ inch plate.

Diving Observations

Dives on the wreck on June 23 focused on the machinery and the forward areas of the wreck due to limited visibility and current. The dives confirmed that the wreck had the same variety, number, and dimensions of the engines as installed in that of *Robert J. Walker*, two horizontal, half beam, condensing engines of the “Lighthall Patent.”

The Lighthall Lever Half-Beam Engine, patented on October 23, 1849 (Patent 6811) by William A. Lighthall of Albany, New York, is illustrated here:

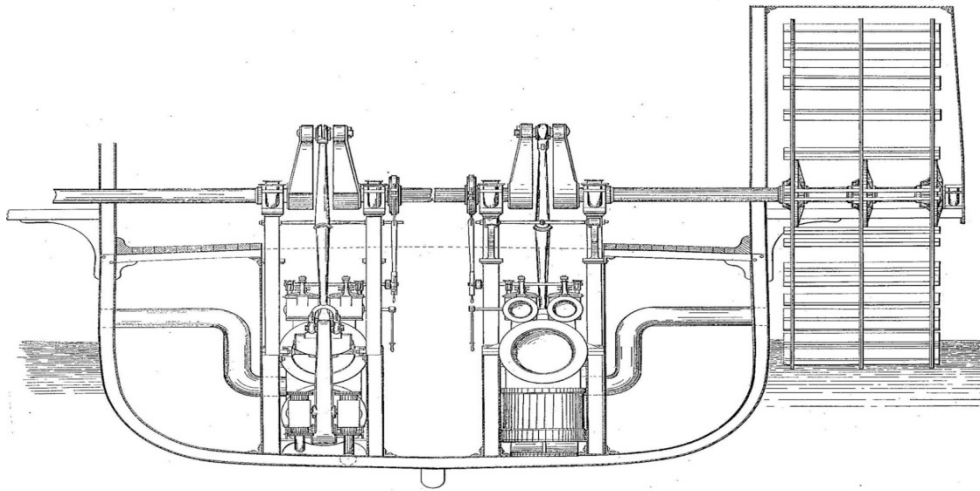

Lighthall Patent Lever Half-Beam Engine as placed in a hull (U.S. Patent Office)

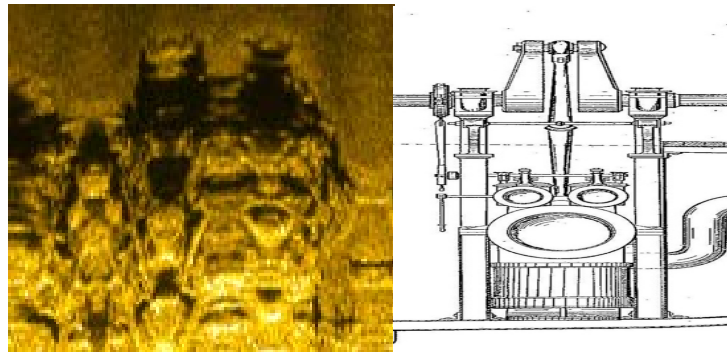

The position and placement of two low, horizontal cylinders are a direct match for those on the wreck. The side-scan sonar image of the engines shows the same form of the cylinder in shadow relief in the image on the left. The cylinders were diver-measured at 2 feet, 9 inches in diameter, which is the recorded dimension for *Walker's* cylinders.

The entablature for the paddlewheel shaft has collapsed to port, but all of the basic structural elements of the engine and the wheel mechanism appear to be in place on the wreck. Utilizing the patent drawing for the engine machinery, the following images delineate features observed on the wreck.

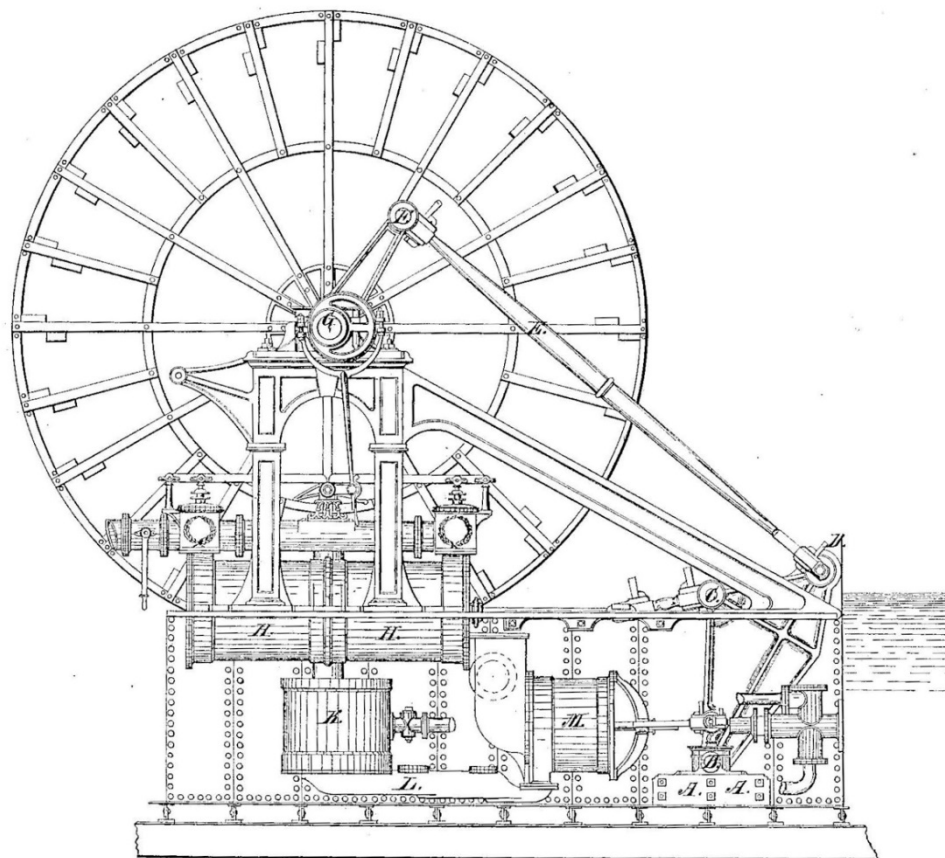

Lighthall's Lever Half Beam Engine Patent, Side Elevation. "Steam cylinders (H) lying horizontally, may be inclined when so required, (K) the condenser, (L) the bed plate, (M) the air pump, (A-A) the pillow block fastened to the keelsons and bottom of the vessel, (B) the beam center, (C) the attachment to the piston or prime mover, (D) the upper center for "connecting rod" (E), (F) the crank pin, and (G) the shaft center." (U.S. Patent Office)



This image shows the cranks on one engine. These cranks connected the crank pin (F) to the shaft center (G) on the engine patent drawings.



The crank connects in this image to the paddlewheel shaft with an eccentric; the entablature that supports the paddlewheel shaft lies tilted to port on the left side of the image.

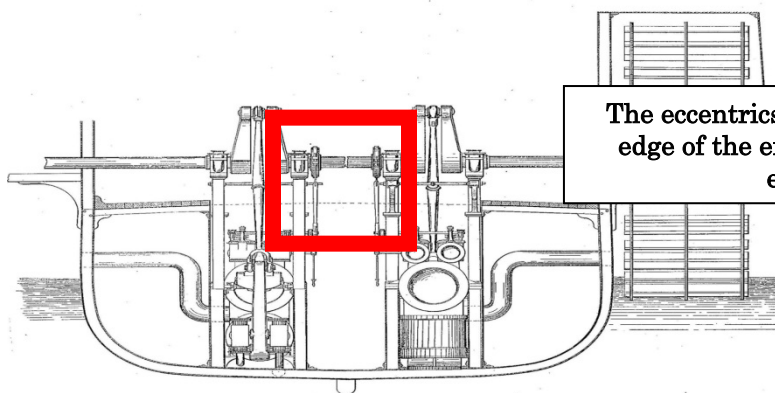

The eccentrics are on the inboard edge of the entablature on each engine.



The paddlewheel shaft, eccentric, and entablature are shown here, aligned in their original position on the starboard engine.



The starboard paddlewheel shaft terminates at three flanges that secured the paddle arms to the paddle shaft. Each flange was spaced three feet apart, indicating that the paddle floats were six feet long. These dimensions match the historically reported dimensions of *Robert J. Walker's* paddlewheels.



The hubs retain the broken stubs of the paddlewheel arms.

The collapsed remains of the boilers lie forward of the engines. The basic shape of the boilers is rectangular, however, few other characteristics were noted during the diving survey due to the boiler's highly deteriorated condition. In addition to the form, the length, as noted in the sonar survey, is comparable with those of *Robert J. Walker*.

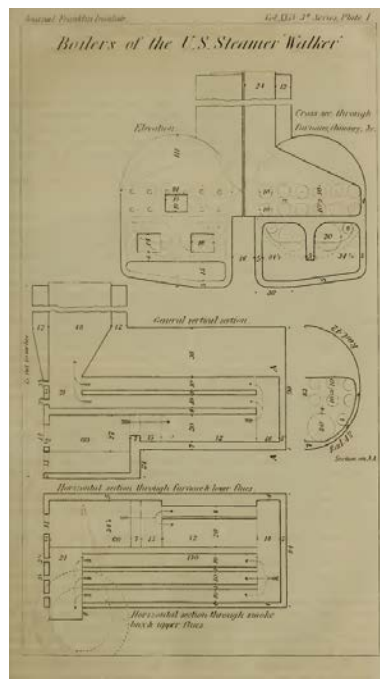

Walker's Boilers (Isherwood 1852)

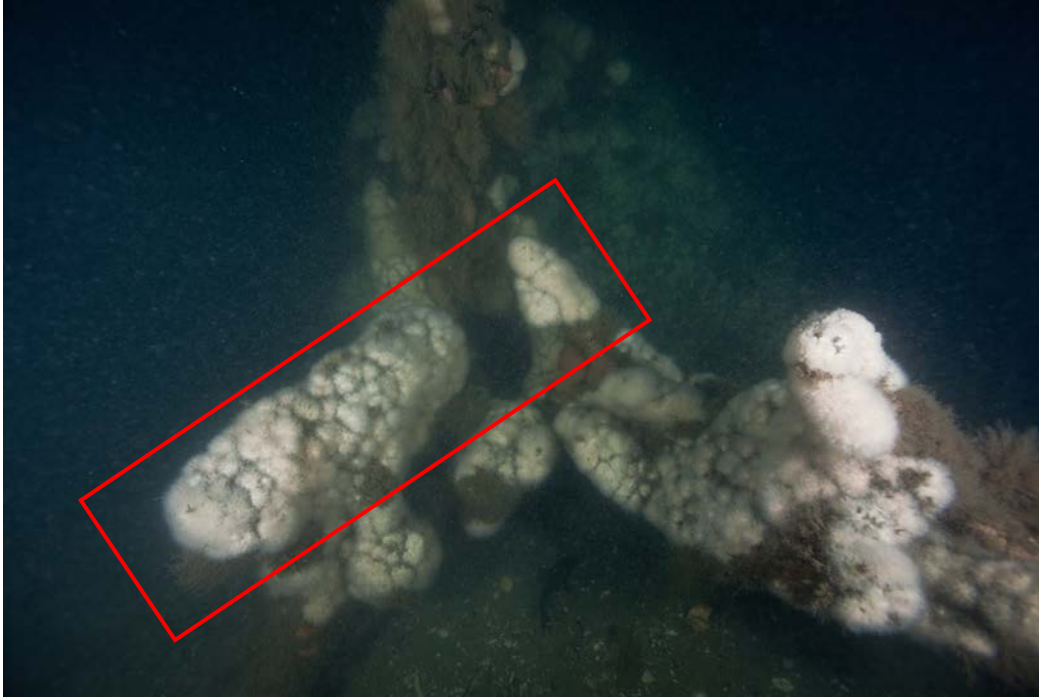

The vessel's hull remains include its bow, which has toppled to the seafloor on its portside. The red outline defines the original location of the bowsprit.



One iron stock Admiralty Pattern anchor lies close in and partially beneath the bow, in what may be its stowed or "catted" position.



A second anchor of the same style lies aft of the bow.



The hull is comprised of iron plate attached to iron T-bar frames. This also conforms to the known characteristics of *Robert J. Walker*. The hull rises above the level of the seabed from the sediment on the starboard side, but disappears into the sediment aft of the engines and boilers on that beam. It is also largely buried by sediment on the port side. However, aft of the bow on the port side, a portion of the hull is exposed. The sediment in this area was disturbed, and in this area, coming

out of the mud, were a number of blue woolen blankets. The blankets did not appear to be modern, and were in various stages of disintegration.



The blankets are tangled in the wreckage. The area in which they lie is where the schooner *Fanny* probably collided with *Robert J. Walker*; the lack of hull here may be indicative of the collision damage. A possible explanation for the blankets may be found in a contemporary account of the sinking:

Some of the men were sent down into the coal-bunker, where they found the water rushing in. They tried to stop the leak with beds and blankets, but found it impossible, as the hole was so large that they no sooner put a bed into it than it was carried through. In this way, one bed after another was lost in the effort. (Vincent 1860:558)

Conclusions

The research design for this project outlined a series of questions to be addressed in the dives.

- 1) Determine site integrity (is there evidence of dragging or displacement of the hull?) How much is left of the vessel?

The wreck appears to be in its original position when it sank, aligned toward the shore and the Absecon Lighthouse, and resting slightly to port. There is evidence of bottom trawl fishing impacts having displaced or shifted the hull, and there is a

degradation of hull structure which may be attributable to trawl net impact. The vessel appears to have sunk by the bow, with the bow striking the bottom first and bending or breaking at the keel, leaving the bow oriented upward.

- 2) Is there any damage which might be attributed to the cause of the wreck? Is there collision damage on the port bow?

There is a gap in the hull aft of the port bow. This, and the presence of the blue woolen blankets aft of it, in the area where the coal bunker was located and where one contemporary account speaks of the crew attempting to plug the hole with bedding suggests that this is collision damage and the cause of the sinking.

- 3) What is the length of the vessel?

As measured by sonar, the wreck is between 131 and 134 feet.

- 4) What is the beam of the vessel?

The beam could not be determined on this dive, but the overall width of the wreck at its maximum extent is just over 35 feet.

- 5) Can the depth of hold or draft be determined?

No.

- 6) Are there sidewheels? What are their dimensions?

The vessel had sidewheels; surviving hub dimensions indicate a float length (width) of six feet, which matches *Robert J. Walker's*. Diameter of the wheels could not be determined as the wheels have disintegrated.

- 7) Is there evidence of masts? If so, how many? What is/was their placement?

No evidence of masts was seen.

- 8) Is there evidence of a stack? If so, how many?

No evidence of stacks was seen.

- 9) What type of iron was used in the hull members? Are the frames T-bar or another type? What are their dimensions?

Iron plate was used to form the hull, and it is affixed to iron T-bar. Dimensions were not obtained.

10) What is the length and thickness of a hull plate(s)?

This could not be determined without excavation.

11) What type of rivets were used, and what is their size?

This could not be determined without excavation.

12) Are there portholes present in the hull? If so, what type are they? What are the dimensions?

No portholes were observed on the site. Portholes removed from the site in past years conform to *Robert J. Walker's* documented rectangular shaped deadlights.

13) Are there engines present? If so, what type of engine are they? How many are there?

Two horizontal, half beam, condensing engines of the "Lighthall Patent" were observed on the wreck. This conforms to the engines of *Robert J. Walker*.

14) What is their placement?

The engines were placed, side by side, midships and aft of the boilers. This conforms to the layout of *Robert J. Walker's* engine room.

15) What is the diameter of the cylinder(s)? What is the shaft length?

The cylinder diameters are 2 feet, 9 inches. The shaft length is six feet. This conforms to the engine dimensions of *Robert J. Walker*.

16) How do the engines connect to the paddlewheel shaft?

The engines connect to the paddlewheel shaft by means of a crankpin and cranks, consistent with *Robert J. Walker's* engine design.

17) Are there boilers present? If so, what type of boiler are they? How many are there? What is their placement?

The collapsed remains of two rectangular boilers were observed forward of the engines. Their length of 15 feet is consistent with *Robert J. Walker's*.

18) Are cannon or cannon balls present on the wreck? If so, can the type/caliber be determined?

No cannon or cannon balls were observed.

19) Are there any diagnostic artifacts on the wreck such as ceramics, glassware, or other materials?

No diagnostic artifacts were observed.

20) Are any manufacturer's marks evident or present?

No manufacturer's marks were observed on any of the machinery.

In conclusion, more than sufficient evidence exists to confirm that the wreck at Site A is the United States Coast Survey Steamship *Robert J. Walker*, lost on June 21, 1860.

Follow Up

The wreck has been identified through site characteristics and diagnostic features and measurements.

The assessment of the wreck is a preliminary step in what should be a more detailed study of the site, and potentially, in time, a process of limited excavation to learn more about the ship. One area that would be a priority for study is the stern, which is buried in sediment. This area was the one in which the Coast Survey activities took place and where material evidence of survey equipment and material culture related to the survey personnel might be located. The area in which the woolen blankets are located is another area where limited testing and recovery of some of the blankets could take place.

The immediate next steps are to reach out to the New Jersey sport and wreck diving communities, and to the recreational fishing community. The identification of the wreck should be shared, as should the changed status of the wreck. *Robert J. Walker* was not abandoned after its wreck, and is therefore still owned by the U.S. Government consistent with the laws and policies that apply to sovereign immune public vessels. For example, the President's Statement on the United States Policy for the Protection of Sunken State Craft explains how the U.S. Government retains title to *all* of its sunken vessels, "unless title has been abandoned or transferred in the manner Congress authorized or directed," regardless of the passage of time.

As the U.S. Government owns *Walker*, laws regarding the protection and management of Government property apply, including, but not limited to: the National Historic Preservation Act (NHPA) ([16 U.S.C. § 470](#)); and laws regarding the destruction or theft of U.S. Government property ([18 U.S.C. § 641 et seq.](#)). Under the maritime law of salvage, public and private owners have the right to

deny salvage. In addition, U.S. sovereign wrecks are immune from arrest under the law of salvage without the consent of the U.S. Government, and in this instance the Department of Commerce (DOC) National Oceanic and Atmospheric Administration (NOAA) as the management agency. As such, the law of salvage and authority of federal Admiralty courts may also provide protection of *Robert J. Walker* from looting and unauthorized salvage.

Robert J. Walker was managed by the U.S. Coast Survey when it sank. Since then, the wreck has neither been abandoned nor been designated surplus property by the United States. As the Coast Survey is now part of NOAA, DOC/NOAA is the federal agency that manages the *Walker* on behalf of the U.S. Government. Because *Walker* is a historic shipwreck, DOC/NOAA also has a responsibility under the NHPA to consider it for listing as a “historic property” on the National Register and to develop a plan for its management and preservation. NOAA will also prepare a National Register of Historic Places nomination for the wreck site. The wreck will be prominently marked on official U.S. nautical charts and other notices. NOAA will ask the fishing community to try to avoid trawling or dredging near it; NOAA will also work with others to avoid any activities that might harm the wreck site and therefore make it less of a diving attraction as well as an historic site.

NOAA will work with stakeholders, including the New Jersey wreck diving and fishing communities; the New Jersey State Historic Preservation Officer; the Department of the Interior; the U.S. Coast Guard; the National Marine Fisheries Service; the Advisory Council on Historic Preservation; and other interested parties in developing a Programmatic Management Agreement under the National Historic Preservation and National Environmental Policy Acts. In order to collect baseline information for the development of management strategies and alternatives, NOAA intends to work closely with the wreck diving community on projects to map and document *Walker* in recognition of the community’s assistance in finding and identifying *Walker*, and its continued interest in diving the site, which will be maintained with no restrictions on non-intrusive access.

It is not NOAA’s intention or plan to make the wreck site of *Robert J. Walker* a sanctuary, nor to require any permits to dive on the wreck. The public will continue to be able to dive the *Walker* to view and take pictures of the wreck so that it can be enjoyed by current and future generations of divers. There will be education and outreach about the history of the wreck site and how diving should be conducted in a manner that is respectful of the site as the final resting place and gravesite of 20 crew members. Divers do not need permits to visit the *Walker*. However, in recognition of the *Walker* as a gravesite and historically significant wreck, the structure and artifacts should not be disturbed (as in moving or removing artifacts) without NOAA authorization.

As a matter of policy and practice, *in situ* preservation – leaving artifacts in place – is the preferred option for preserving the wreck for the public interest in this wreck as a destination for diving and bottom fishing, as a memorial for the lives that were lost when it sank, and the archaeological and historical value of the site. *See*: [NOAA Guidelines for Research, Exploration and Salvage of RMS *Titanic*, 66 Fed. Reg. 18905, April 12, 2001](#) for guidelines on exploring and researching a shipwreck that is also a gravesite. As *Walker* rests at a depth of 85 feet in a mud hole, partially covered by silt, the wreck appears to be sufficiently preserved *in situ* while still accessible to the public.

NOAA's management plan will facilitate continued diving and fishing activities in a manner consistent with historic preservation law and policy and to enhance the diving and interpretive experience. While *in situ* preservation is preferred and collecting *Walker* artifacts as “souvenirs” will not be authorized, NOAA is willing to cooperate in scientific research and recovery of artifacts for conservation, curation, and display in a museum open to the public done in compliance with the [Federal Archeology Program \(FAP\)](#) and the NHPA will be part of its management. *See*: [Curation of Federally Owned and Administered Archaeological Collections, 36 C.F.R. 79.](#)

NOAA will reach out to local museums, beginning with the New Jersey Maritime Museum in Beach Haven, the Absecon Lighthouse Museum in Atlantic City, and the New Jersey Shipwreck Museum in Wall to investigate partnerships and exhibits on *Robert J. Walker*. Because Absecon Light was the intended final destination for *Walker* as the crew desperately tried to reach shore after the collision, and the wreck is closest to it, NOAA will work with the Absecon Light Museum to create a permanent memorial there to the twenty lost crew members of *Walker*, who currently have no memorial to mark their sacrifice in the line of duty.

There are a number of artifacts in the community in the possession of divers who have collected them from the wreck site in the past and before the identity of the wreck was known. Some of those recoveries, such as those of the rectangular portholes, were important clues in establishing the wreck's identity. NOAA is not seeking any action against persons who recovered artifacts before the public knew it was U.S. Government property. NOAA recognizes that some divers and artifact collectors want to contribute to the scholarship of our nation's maritime heritage through the artifacts in their possession. In regard to those artifacts, NOAA proposes that people can donate their *Walker* artifacts to NOAA for conservation and public display at one or all of the public museums in New Jersey. In addition to sharing the story of the *Walker*, this exhibit would recognize the role of wreck divers in locating and identifying the wreck as well as helping tell its story.

NOAA is not creating a permit system nor undertaking any actions that necessitate an Environmental Assessment under the National Environmental Policy Act.

However, NOAA will prepare an Environmental Assessment as a means to proactively assess the site and establish a baseline for understanding what any impacts might be, including any potential development by other agencies, Federal or State, on the site from dredging, energy development projects, etc.

In addition to this report, NOAA will continue to research the site and *Walker's* history, working with the New Jersey wreck diving community as well as any and all other interested parties. NOAA's genealogist, Lisa Stansbury, will work with the archives and other sources to better understand the life stories and family connections, and to find modern descendants of those members of *Walker's* crew who lost their lives and to share their stories with the public. NOAA will also foster the means for private divers to contribute to ongoing research through specialized training and using the results to provide 3D online maps, dive slates, etc.

The story of *Robert J. Walker* is an important one in the development of the United States and, in particular, ensuring safe navigation for those who work on the nation's waters, and for the facilitated and safe flow of commerce by water. It is a story of innovation, of science at sea, and of long hours of service to the nation. It is also a story of those who paid the ultimate price for that service and devotion to duty.



Commander Lawrence Krepp, Lieut. Commander Chris van Westendorp, and Ensign Eileen Pye prepare to honor the lost crew of *Robert J. Walker* off the New Jersey coast on board the NOAA ship *Thomas Jefferson* on June 21, 2013. (NOAA)

Acknowledgements

The goal of remembering and memorializing the service and sacrifice of *Robert J. Walker* and its crew has been a long lasting goal of NOAA's unofficial historian, retired Captain Albert Theberge. This project would not have taken place without his commitment to that cause. We gratefully acknowledge the assistance and participation of Joyce Steinmetz and Timothy J. Runyan in focusing attention on Site A as the potential wreck site.

We also gratefully acknowledge the participation of those fishermen and divers who worked with Joyce Steinmetz, and in particular Captain Eddie Boyle. We also thank John Cloud of the NOAA Central Library for his support and research, Mark Mullan of the National Archives, and Dr. Robert Browning, the Chief Historian for the U.S. Coast Guard. The support and participation of Anna Gibson Holloway and David Krop from The Mariners' Museum, in Newport News, is also gratefully acknowledged.

The support of the Office of Coast Survey and their partnership is gratefully acknowledged. The support of Rear Admiral Gerd Glang, Captain Jon Swallow, Commander Shep Smith, Jeff Ferguson, Matt Kroll, Dawn Forsythe, and Vitad Pradith made this project happen.

Thanks are also due for the support afforded by Rear Admiral Michael Devany of the Office of Marine and Aircraft Operations and in particular Commander Lawrence Krepp and the crew and officers of the NOAA ship *Thomas Jefferson* who conducted on-site surveys.

The support of the United States Coast Guard in this project is also gratefully acknowledged. Coast Guard Station Atlantic City in the Coast Guard's Fifth District hosted *SRVx*. We thank Station Commanding Officer Commander K. Moore and his crew for their hospitality and assistance.

We also acknowledge the support and assistance of NOAA's Office of General Counsel, International Law, notably Peter Oppenheimer, Ole Varmer, Lydia Barbash-Riley, and Chauncey Kelly.

The Office of National Marine Sanctuaries team, both on board the NOAA ship *SRVX*, and ashore, also made this project happen. Daniel J. Basta, Ted Lillestolen, Reed Bohne, David Alberg, Jeff Gray, Craig McDonald, Russ Green, Tane Casserley, Matt Lawrence, Pasquale DeRosa, Steve Bawks and Todd Recicar.



The 2013 *SRVx* team on the dock at Atlantic City at the end of the *Robert J. Walker* mission. L to R: Steve Bawks, Lydia Barbash-Riley, David Krop, Vitad Pradith, David Alberg, Tane Casserley, Russ Green, Dan Basta, Matt Lawrence, Jim Delgado, Todd Recicar, and Pasquale DeRosa.

Sources

Bache, Alexander D. (1861) *Report of the Superintendent of the United States Coast Survey, Showing the Progress of the Survey, During the Year 1860*. Government Printing Office, Washington.

Blacker, J.F. (1911) *Nineteenth-Century English Ceramic Art*. Little, Brown & Company, Boston.

Brown, Alexander Crosby (1951) Notes on the Origins of Iron Shipbuilding in the United States: 1825-1861. MA thesis, The College of William and Mary, Williamsburg, VA.

Brown, Allen H. (1881) The Character and Employments of the Early Settlers of the Sea-Coasts of New Jersey. *Proceedings of the New Jersey Historical Society, Second Series*, Vol. VII:27-64.

Brown, David K. (1993) *Paddle Warships: The Earliest Steam Powered Fighting Ships: 1815-1850*. Conway Maritime Press, London.

Browning, Robert (1992) The Lasting Injury: The Revenue Marine's First Steam Cutters. *American Neptune* 52(1): 25-37.

Department of the Treasury (1847) *An Account of the Receipts and Expenditures of the United States, For the Year 1847...* Ritchie & Hiess, Washington D.C.

Gentile, Gary (2002) *Shipwrecks of Delaware and Maryland*. Gary Gentile Productions, Philadelphia, PA.

Gentile, Gary (2002b) *Shipwrecks of New Jersey South*. Gary Gentile Productions, Philadelphia, PA.

Isherwood, Benjamin (1852) "Notes on the U.S. Surveying Steamer *Walker*," *Journal of the Franklin Institute*, Vol. XXIV, Third Series (1), 49-55.

Letter from the Acting Secretary of the Treasury (1847) *Report of the Superintendent of the Coast Survey... December 15, 1847*. Senate Executive Doc. 6, 309th Cong. 1st Sess.

Rodgers, Bradley A. (1996) *Guardian of the Great Lakes: The U.S. Paddle Frigate Michigan*. University of Michigan Press,

Sands, Benjamin Franklin (1899) *From Reefer to Rear-Admiral: Reminiscences and Journal Jottings of Nearly Half a Century of Naval Life, 1827 to 1874*. Frederick A. Stokes Company, New York.

Smith, Horatio Davis (1989) *Early History of the United States Revenue Marine Service or (United States Revenue Cutter Service) 1789-1849*. Reprint of 1932 Naval Historical Foundation Publication. U.S. Coast Guard Bicentennial Publication, Washington, DC.

Steinmetz, Joyce H. (2010) Examining Mid-Atlantic Ocean Shipwrecks and Commercial Fish Trawling and Dredging. Master's Thesis, East Carolina University, Greenville, NC. Publication Pending.

Steinmetz, Joyce H. (2012) Side-Wheel Paddle Steamer *Admiral DuPont*, 1847-1865: Identification, History, and Structural Integrity. *ACUA Underwater Archaeology Proceedings 2012*:109-115.

Steinmetz, Joyce H. (2013) Search for the U.S. Coast Survey Steamer *Robert J. Walker*, 1847-1860: Search Area & Archaeological Features. PowerPoint Presentation to NOAA ONMS MHP and OCS, April 30.

Sterling, Dorothy, ed. (1973) *Speak Out in Thunder Tones: Letters and Other Writings by Black Northerners, 1787-1865*. Doubleday, Garden City, N.J.

Stick, David (1982) *Graveyard of the Atlantic: Shipwrecks of the North Carolina Coast*. University of North Carolina Press, Chapel Hill.

Theberge, Captain Albert E. (1998) *The Coast Survey: 1807-1867*. National Oceanic and Atmospheric Administration, Silver Spring, Maryland.

Trimble, William F. (1975) From Sail to Steam: Shipbuilding in the Pittsburgh Area, 1790-1865. *Western Pennsylvania Historical Magazine*, Vol. 58(2), 147-167.

Vincent, Francis, ed. (1860) *Vincent's Semi-Annual United States Register...*
Francis Vincent, Philadelphia.